



01/03/2019

## Parts List

ITEM	PART NO.	DESCRIPTION	QTY
1	490-133-000	BODY - SNORKEL (SS62HF)	1
2	000-135-960	4" AIR RAM ASSEMBLY	1
3	490-032-000	BRACKET - UPPER MOUNTING	1
4	000-002-100	BOLT - HEX - 6mm x 1.0 x 14mm (SEMS)	2
5	000-1024-300	BOLT - B/H 5.0mm x 0.8 x 25mm - S/S	3
6	000-320-350	WASHER - BODY 5mm x 15mm - S/S	3
7	490-992-000	SPACER - UPPER MOUNTING BRACKET	3
8	000-954-300	RIVNUT - 5mm x 0.8 x 13mm	3
9	000-110	STUD - 8mm x 1.25 x 25mm - S/S	6
10	000-311-300	WASHER - BODY - 8.4mm x 32mm - S/S	6
11	000-205-300	NUT - NYLOC - 8mm x 1.25mm - S/S	6
12	490-024-000	HOSE - AIR ENTRY (Flanged)	1
13	000-1911	CLAMP - HOSE - 100/120mm - S/S	1

14	490-025-000	PLATE - HOSE SUPPORT - Main - S/S	1
15	490-025-100	PLATE - HOSE SUPPORT - Lower - S/S	1
16	490-025-200	PLATE - HOSE SUPPORT - Side- S/S	1
17	000-958-175	POP RIVET - 4.0mm x 17mm	10
18	000-094-300	BOLT - B/H 4.0mm x 0.7 x 20mm - S/S	3
19	000-300-350	WASHER - BODY - 4.0mm x 12mm - S/S	3
20	000-223-300	NUT - NYLOC - 4.0mm x 0.7mm - S/S	3
21	490-217-000	TEMPLATE - AIRCLEANER (Main)	1
22	490-217-100	TEMPLATE - AIRCLEANER (Side)	1
23	490-217-200	TEMPLATE - AIRCLEANER (Side Cutting)	1
24	000-1931/B	CLAMP - HOSE - SIZE 64 (BLACK)	1
25	490-017-100	TEMPLATE - INTERNAL PANEL	1
26	490-017-000	TEMPLATE - GUARD PANEL	1

## Installation Guide

### Fitment to:

- Left Hand Side

### Fitting Time:

- 210min

### Special Tools:

- Body saw (reciprocating)
- Step drill
- 4.5mm, 7.0mm, 14.5mm Drill Bits
- Rivet Nut Pliers/Gun  
*Rivet Nut Gun: Wurth article no: 0949 16 or one with a head size no larger than 14mm diameter.*
- Sikaflex 227 adhesive sealant
- Masking tape
- Loctite 243 (thread lock)
- Touch-up paint
- Prep-wash

**Prior to commencing the installation, it is the installer's responsibility to verify that all components and particularly the template (Item 26) are correct.**

1

Remove the Left Hand factory side step, mud flap, inner guard liner and the air cleaner assembly in accordance with the factory service manual.

2

Remove and discard the air inlet duct, air inlet deflector and air inlet flange.

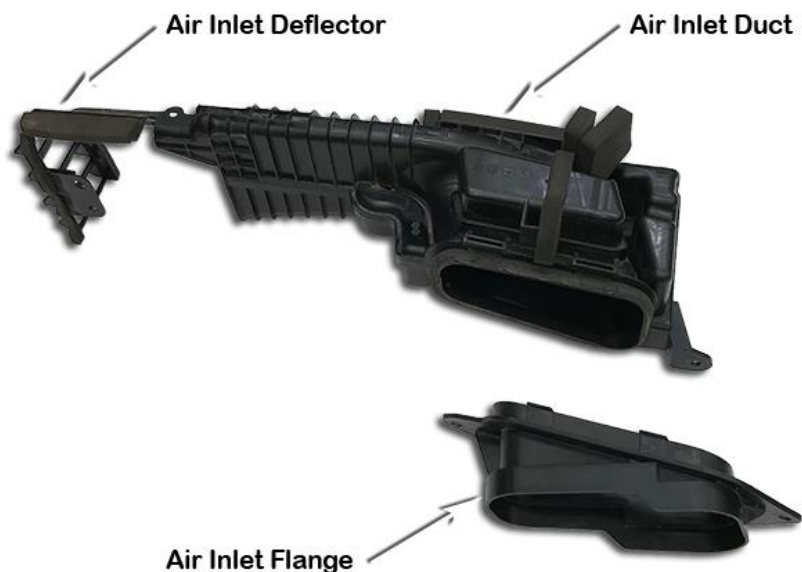

3

Remove and Discard the Left Hand fender vent.



4

Remove and discard the perforated section of the guard panel template (item 26) as shown.

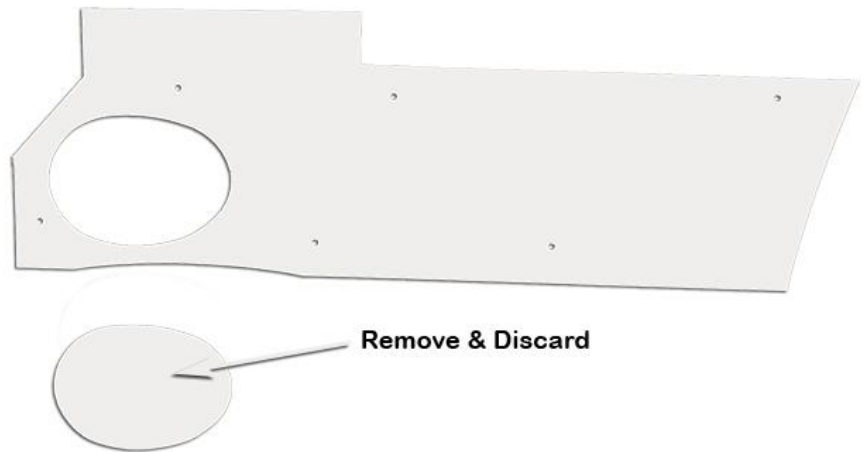

5

Align the guard panel template (Item 26) to the upper and rear edges of the Left Hand guard panel as shown.

Tape the template to the guard with masking tape.

Mark all hole positions and the cut-out section with a felt tip pen.

Remove the template.

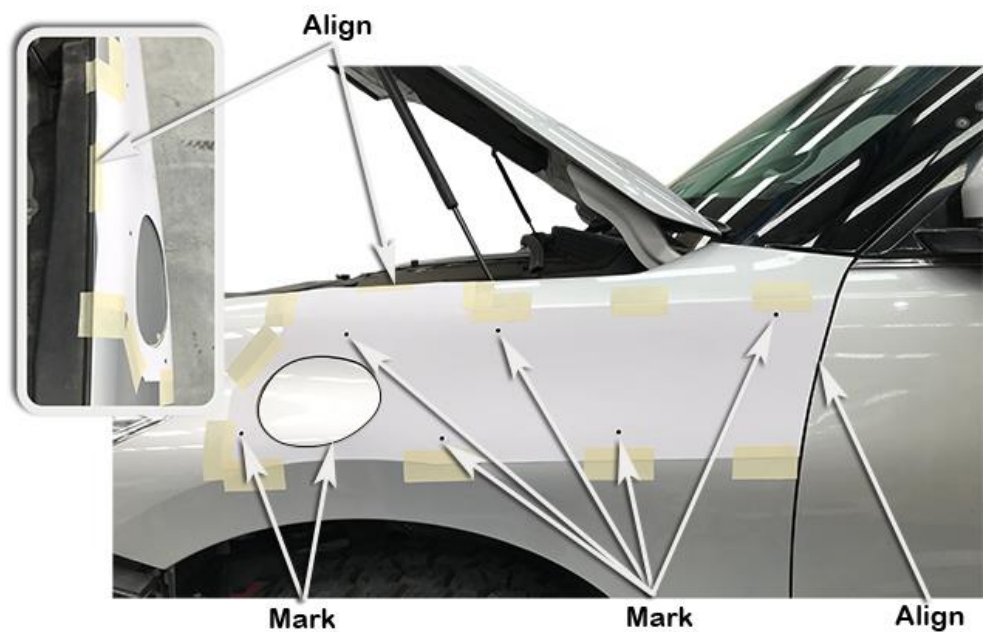

6

Drill a pilot hole for each of the marked hole positions.

Use a step drill to drill the 6 mounting holes to 16mm diameter.

Drill 2 or 3, 10mm diameter holes in the cut-out section for a start/stop point for the body saw, using the body saw cut the main hole in the guard panel as marked from the template cut-out in step 5.

Deburr and paint all holes.

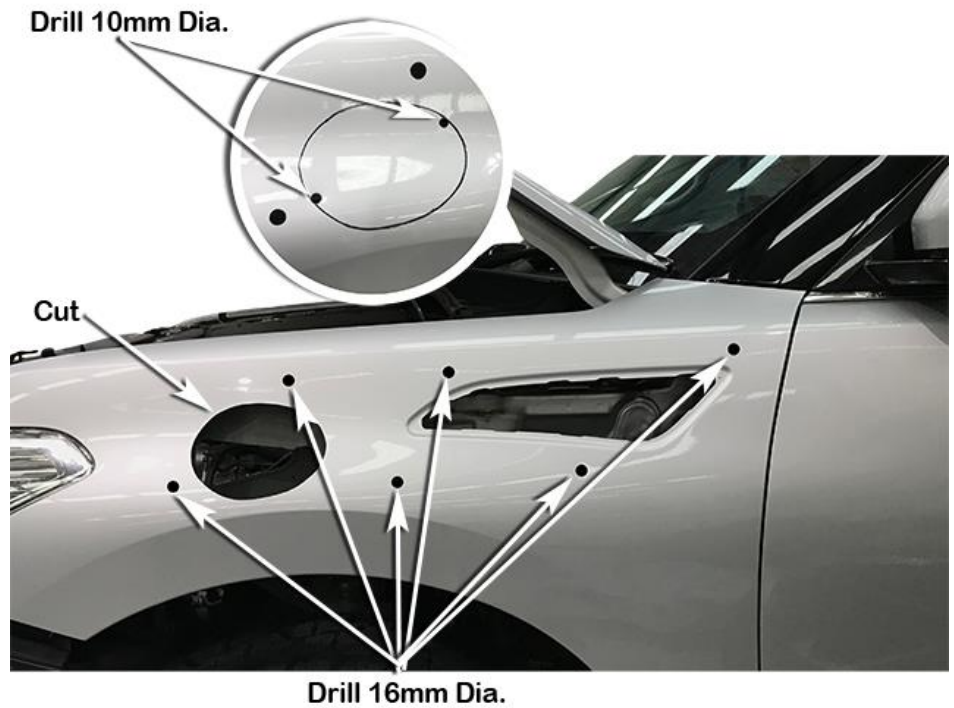

7

Align the internal panel template (item 25) as shown to the lower edge and double panel, mark the cut-out and remove the template.

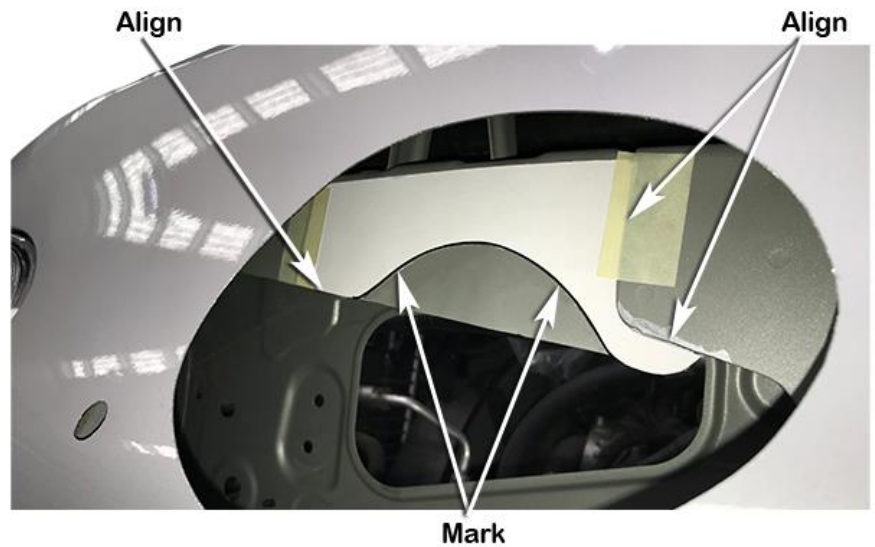

8

Using the body saw cut away the marked section of internal panel.

Deburr and paint.

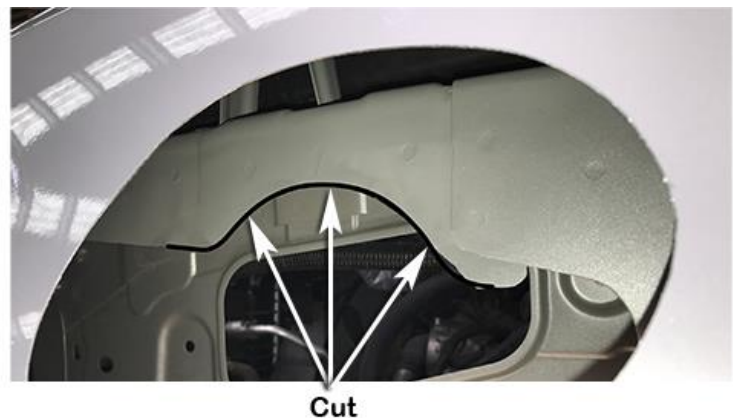

Install the upper mounting bracket (Item 3) to the snorkel body (Item 1) with hex bolts (Item 4).

Apply Loctite 243 to each of the stainless steel mounting studs (Item 9) and install the studs finger tight into the snorkel body (item 1) mounting inserts as shown.

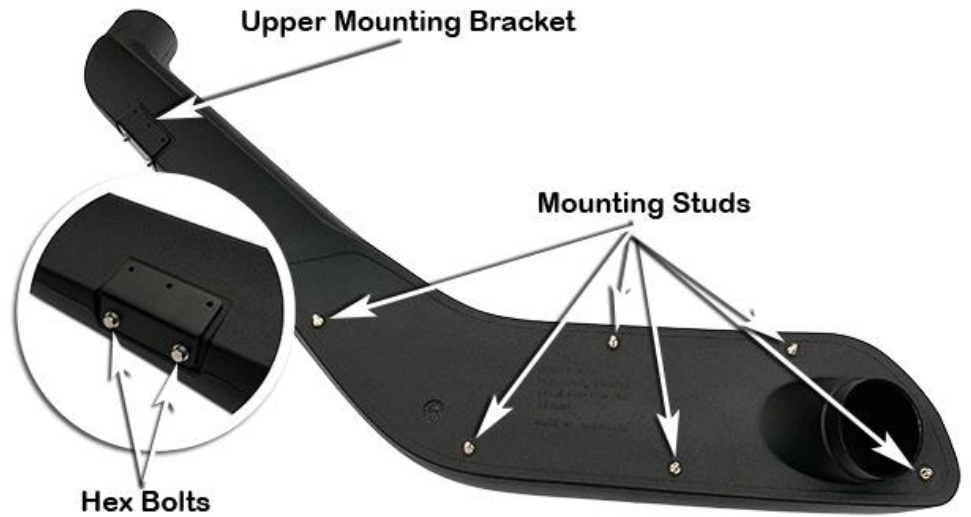

Place a strip of masking tape along the plastic A-pillar trim.

Carefully install the snorkel body (Item 1) to the guard panel.

With the snorkel body correctly positioned, mark the outline of the upper mounting bracket (Item 3) onto the masking tape.

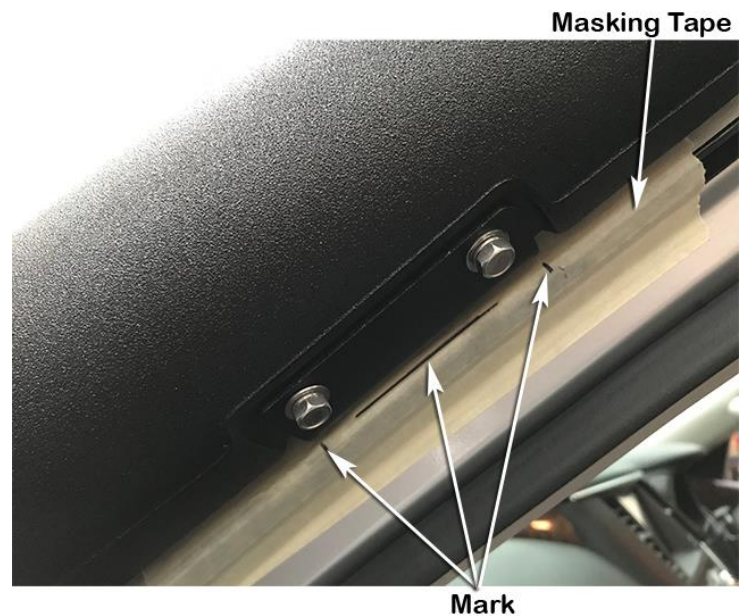

Remove the snorkel body (Item 1) from the vehicle, remove the upper mounting bracket (Item 3) from the snorkel body.

Position the upper mounting bracket onto the plastic A-pillar trim and align the bracket with the marked bracket outline.

Mark the three mounting hole positions with a felt tip pen.

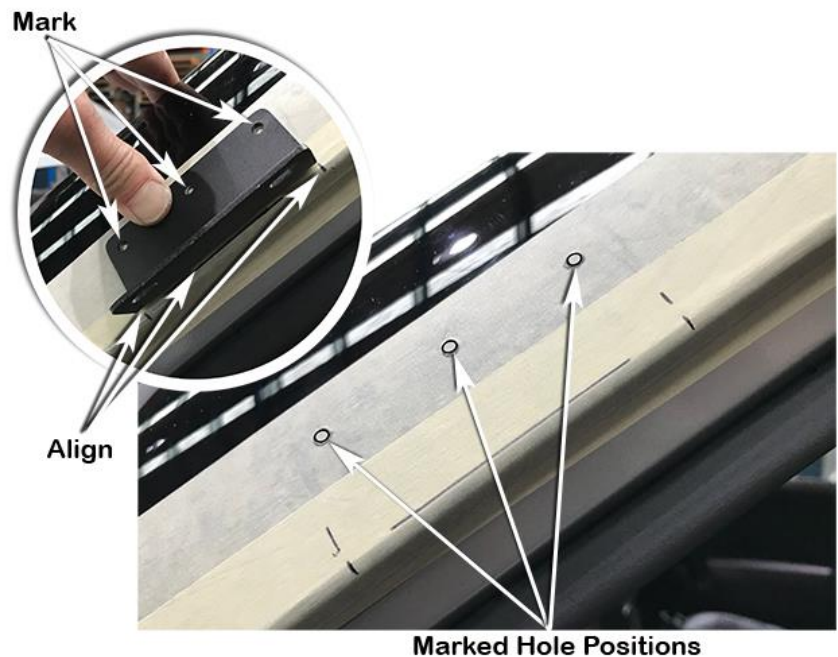

12

Drill Pilot Holes

Drill a pilot hole for each of the three marked hole positions, through the plastic A-pillar trim and through the steel A-pillar panel below. Drill both the plastic A-pillar trim and the steel A-pillar panel holes to 7.0mm diameter with a 7.0mm drill bit.

Using compressed air remove the metal swarf from the A-pillar trim cavity.

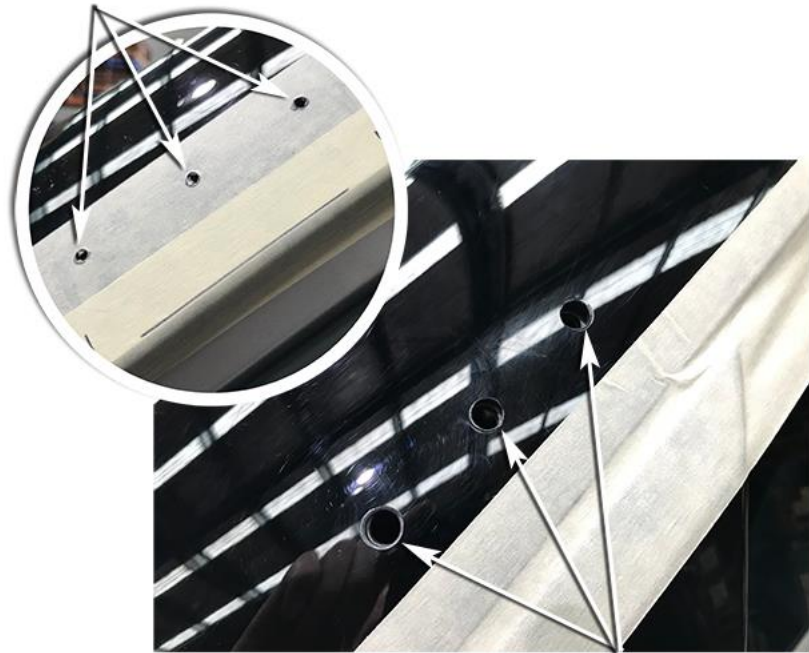

Drill 7mm Dia.

13

Using a 14.5mm drill bit, drill the three holes in the plastic A-pillar trim to 14.5mm diameter.

**Note: Do not drill into the steel A-pillar Panel.**

Using compressed air, remove the plastic swarf from the A-pillar trim cavity.

Deburr and paint the three 7.0mm diameter holes in the steel A-pillar panel.

Deburr & Paint 7mm Dia. Holes

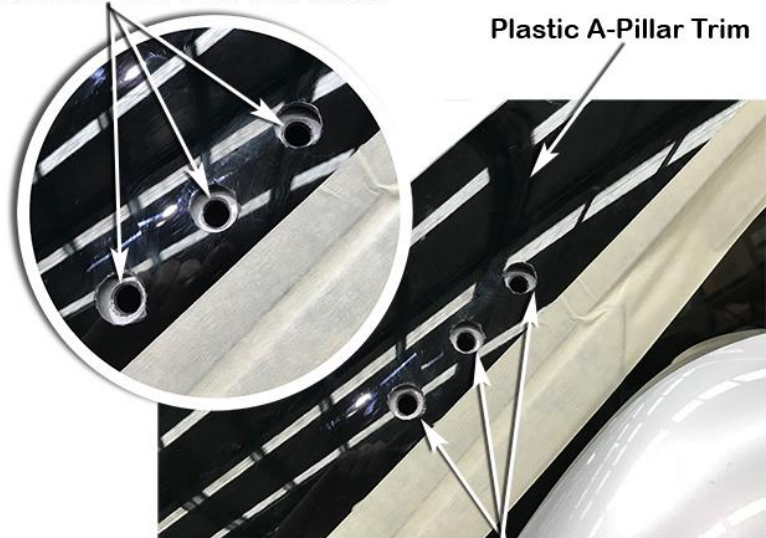

Drill 14.5mm Dia.

14

Using the Rivet Nut Pliers install the three M5 riv nuts (item 8) into the three 7.0mm diameter holes in the steel A-pillar panel.

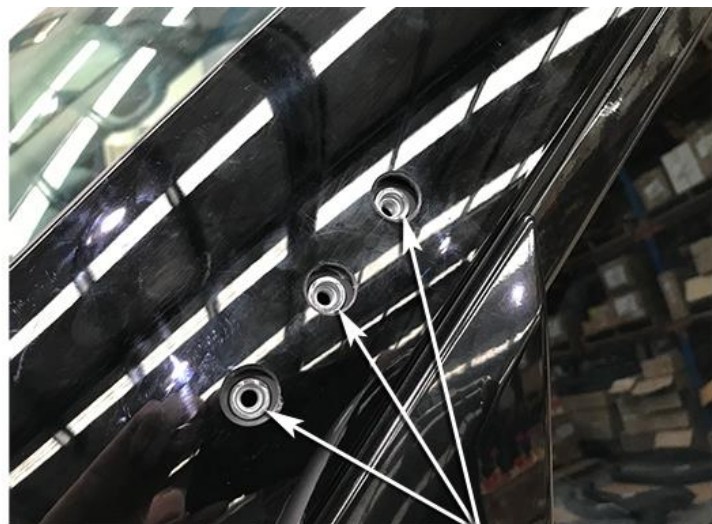

M5 Riv Nuts

15

Install the three A-pillar bracket spacers (item 7) into the plastic A-pillar trim.

Install the upper mounting bracket (item 3) and secure to the A-pillar with M5 x 25mm button head bolts (item 5) with M5 x 15mm body washers installed (item 6).

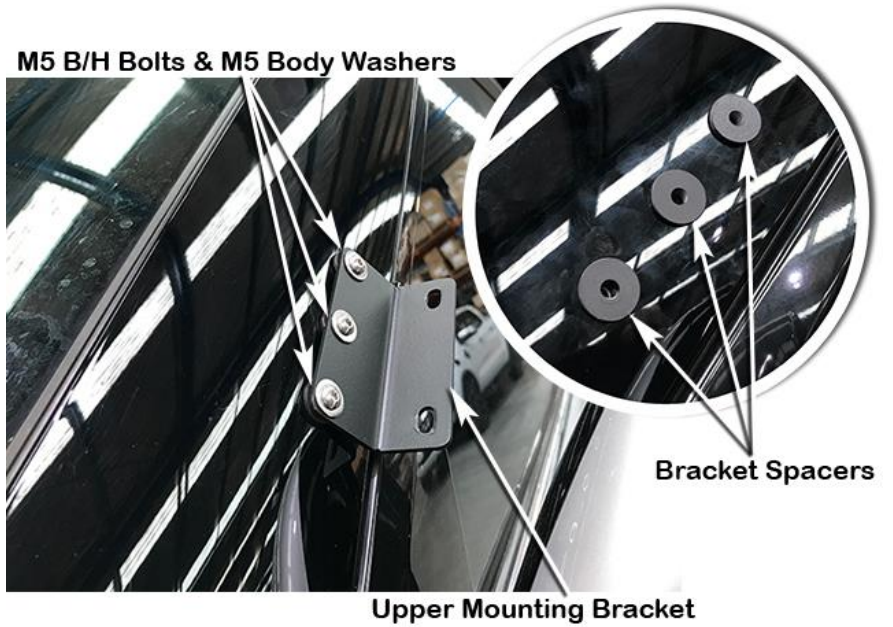

16

Remove and discard the foam sealing tape from the air cleaner inlet snout.



17

Align the side cutting template (item 23) to air cleaner base inlet snout as shown, mark the cut line and remove the template.





Align the side template (item 22) onto the air cleaner base mounting bracket as shown, mark the two hole positions.  
Remove the template.

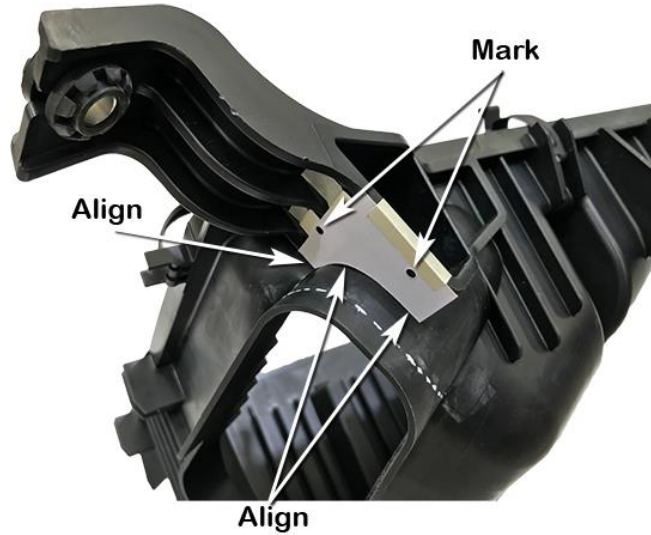

Align the main air cleaner template (item 21) to the 1<sup>st</sup> rib, around the air cleaner clip mount and under the top section of the air cleaner base, with the template correctly aligned tape the template to the air cleaner base, mark all hole positions and the required cut out as shown.  
Remove the template.

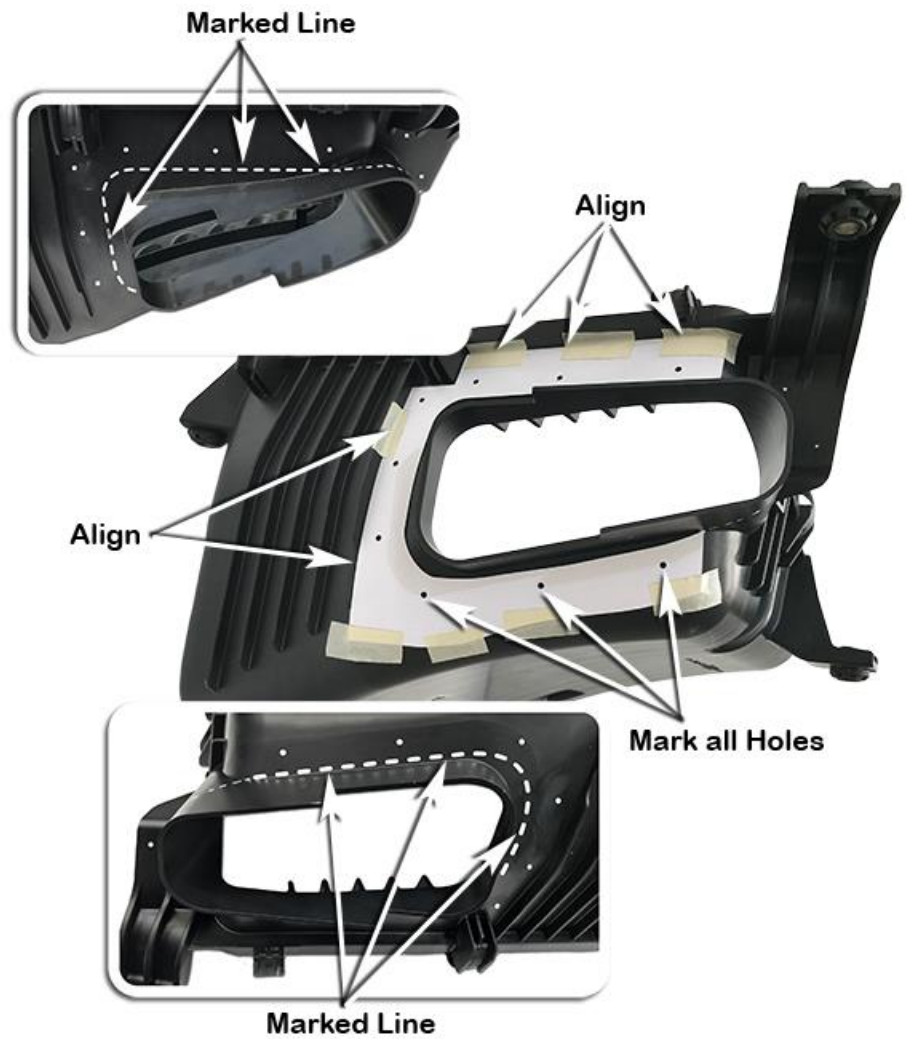

Drill a pilot hole for each of the marked hole positions, using a 4.5mm drill bit, drill all the holes to 4.5mm diameter.

Using the body saw, cut the new air cleaner base inlet hole as marked from the templates.

**Note: Cutting on the outside of the marked lines.**

Using a file, deburr the cut edges of the new air cleaner base inlet hole.

Drill all Holes 4.5mm Dia.



Using the body saw trim off the 5 upper ribs on an angle as shown.

Using the body saw / sharp knife completely remove the side rib as shown.

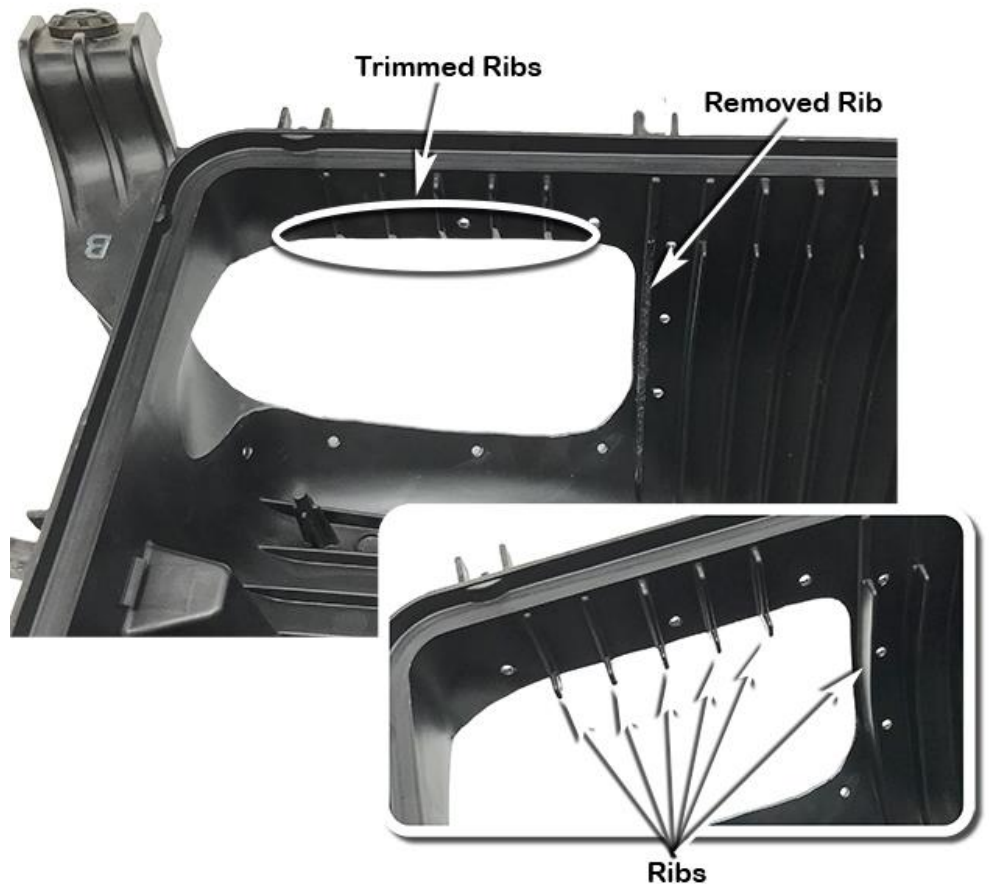

Install the air entry hose (item 12) onto the air cleaner base, align the hose to the 4.5mm diameter holes, with the hose correctly positioned drill the two remaining air entry hose mounting holes with a 4.5mm drill bit.

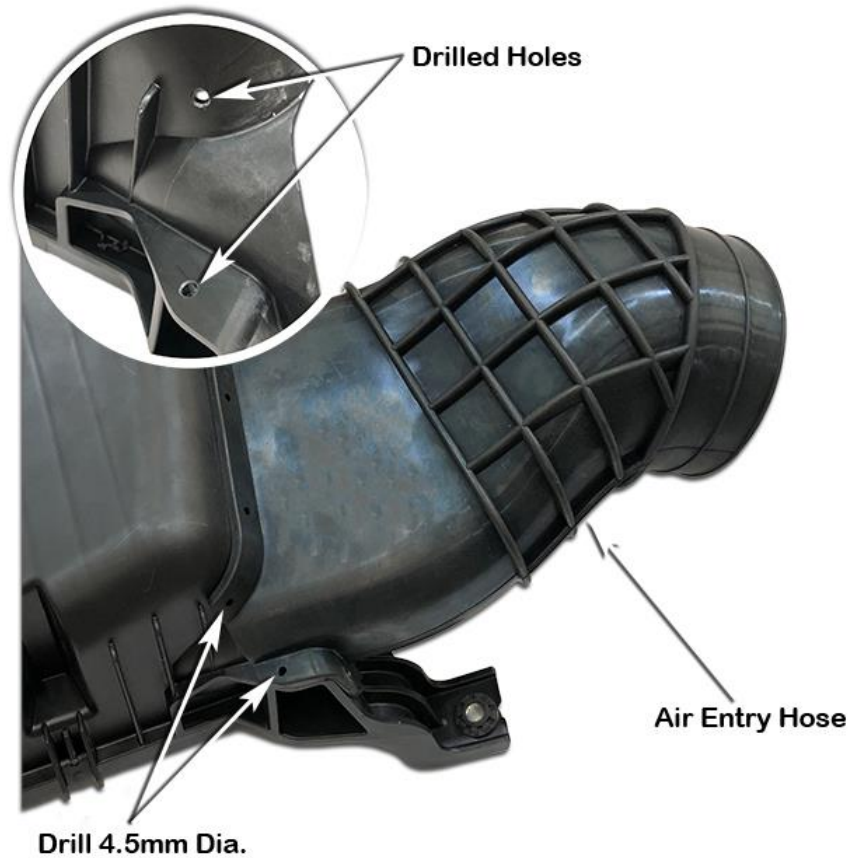

The main and lower hose support plates (items 14 & 15) require bending, align each of the plates onto the air entry hose (item 12) and bend the support plates to the profile of the air entry hose mounting flange as shown.



Apply adhesive sealant to the mating surfaces of the air cleaner base and air entry hose (item 12).

Install the air entry hose (item 12) onto the air cleaner base, install the main and lower hose support plates (item's 14 & 15) to the hose, install all ten pop rivets (item 17) from the inside of the air cleaner base, with the pop rivets installed, use a pop rivet gun to secure all ten pop rivets as shown.

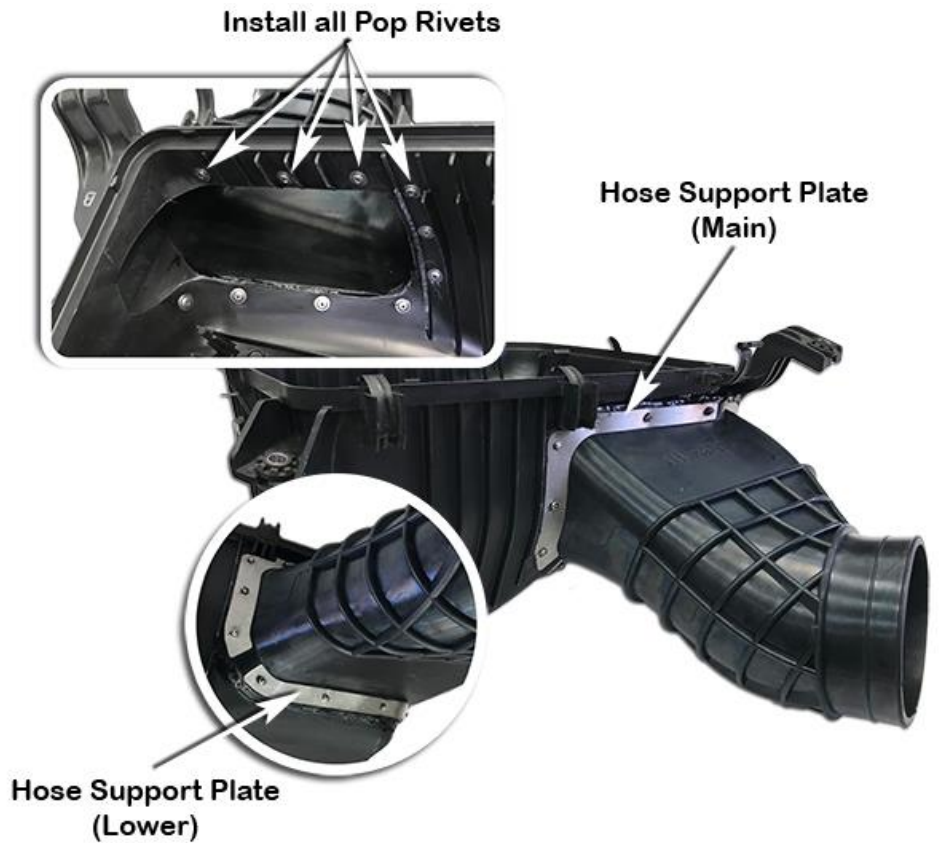

Install the side hose support plate (item 16) to the air entry hose, secure the side hose support plate to the air cleaner base with M4 x 20mm button head bolts (item 18), M4 x 12mm body washers (item 19) and M4 nyloc nuts (item 20) as shown.

**Note: Do not overtighten the M4 Fasteners.**

Clean-up any excess sealant to ensure a neat finish.

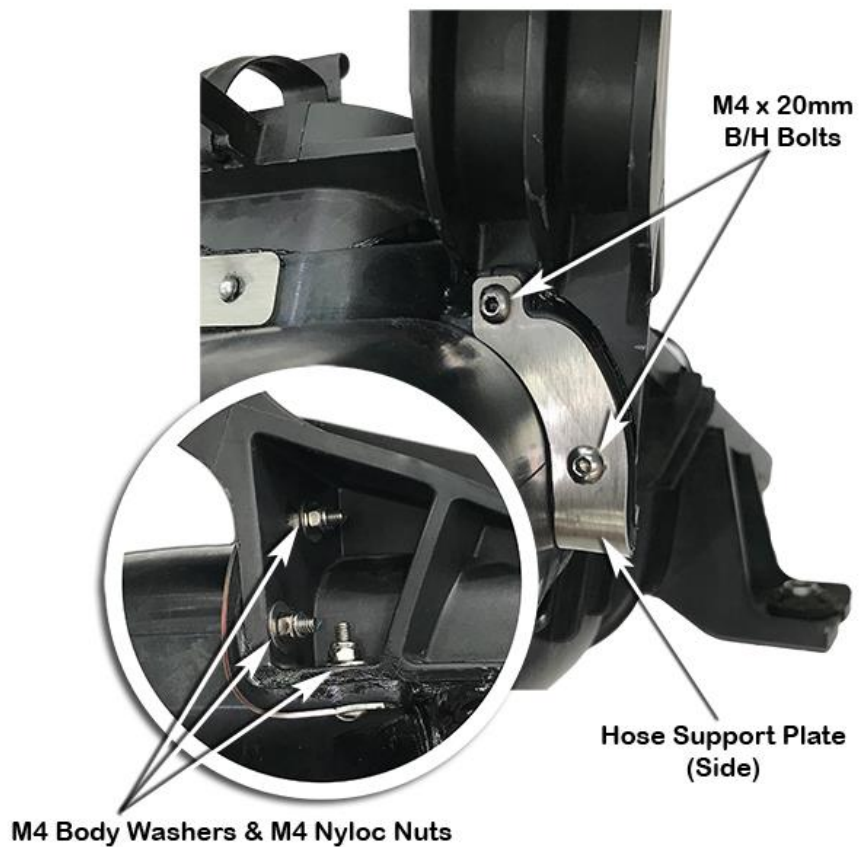

**INSTALLER OPTION:****VQ40DE V6 Engine:**

Air cleaner base contains a drain valve as shown.

**VK56VD V8 Engine:**

Air cleaner base contains a drain hole as shown.

These can permit water to enter the air intake.

Safari advises that the drain valve or drain hole should be sealed to ensure a watertight installation.

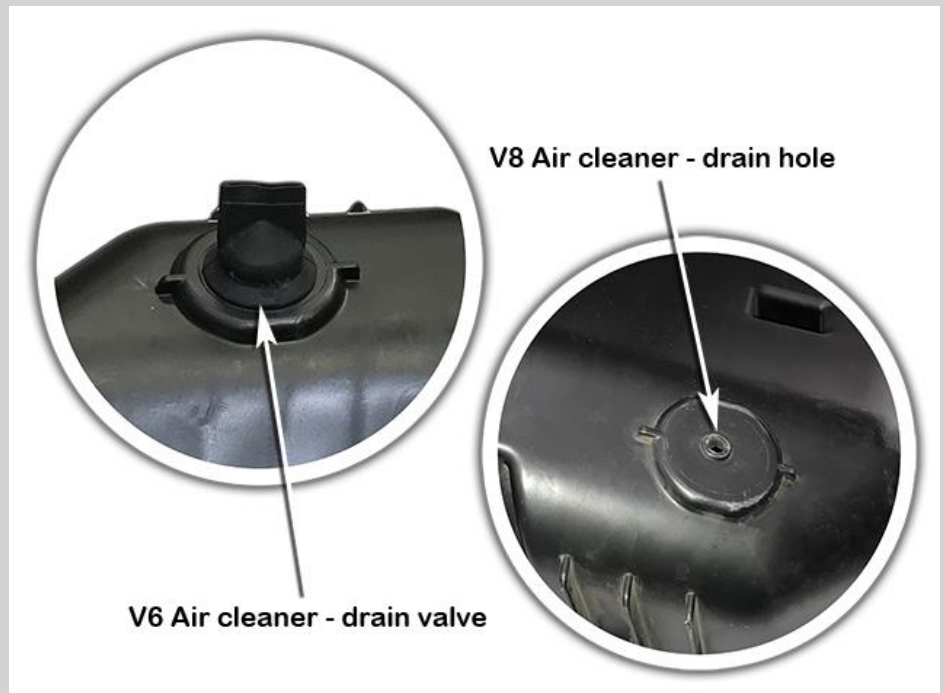

Squashing the end of the air entry hose inwards, install the air entry hose through the hole in the inner guard panel, with the air cleaner base correctly installed into the vehicle. Fasten with the original mounting hardware.

Loosely install a 100/120mm hose clamp (item 13) over the air entry hose inlet.



100/120mm Hose Clamp



Air Entry Hose

Apply lubricant to the inlet of the air entry hose (item 12).

Carefully install the snorkel body (item 1) to the guard panel, guiding the snorkel body outlet snout into the air entry hose (item 12).

Align the snorkel body to the guard panel and upper mounting bracket, fasten the snorkel body to the guard panel with body washers (item 10) and nyloc nuts (item 11).

Fasten the snorkel body to the upper mounting bracket with hex bolts (item 4).

**Body Washers & Nyloc Nuts**



**Air Entry Hose**

**Hex Bolts**

Ensure the air entry hose is correctly installed onto the snorkel body outlet, orientate the 100/120mm hose clamp (item 13) as shown and tighten the hose clamp.

**100/120mm Hose Clamp      Snorkel Body Outlet**



**Air Entry Hose**

30

Loosely install the black hose clamp (Item 24) to the base of the air ram assembly (Item 2).

Install the air ram assembly onto the snorkel body (Item 1).

Align the air ram assembly and tighten the black hose clamp (Item 24).



31

Install the inner guard liner, mud flap, factory side step, air filter element, air cleaner lid, reconnect sensor wiring and any other items that may have been removed in accordance with the factory service manual.

32

**N.B: It is the installer's responsibility to ensure that all connections are water tight.**