

MAXXFAN[®]

INSTALLATION INSTRUCTIONS, INFORMATION AND OPERATING GUIDE FOR MAXXFAN[®] Plus MODELS 4000KI • 4500KI • 4540KI

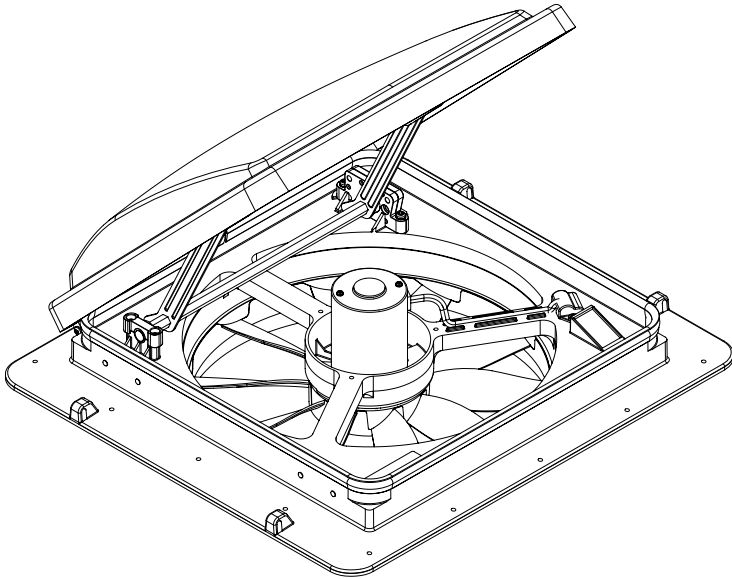

READ AND SAVE THESE INSTRUCTIONS

NOTE: Refer to supplied Operating Instructions regarding the model you have purchased.

The **MAXXFAN** installs into a standard Caravan roof opening of 355mm by 355mm.

To determine if your roof opening is correctly sized, simply remove the interior ceiling garnish trim ring of your existing roof vent and measure the ceiling opening or verify the opening is large enough by sliding the **MAXXFAN** interior Garnish trim ring into the opening.

The **MAXXFAN** is designed for a minimum roof thickness of 50mm to a maximum of 110mm. If your roof thickness is less than 50mm, build additional thickness at the ceiling opening using wood or other suitable material. Longer Garnish Rings are available to allow installation in caravans with thicker roof sections.

The **MAXXFAN** is designed for a nominal 12 Volt DC system and requires a circuit capable of supplying a minimum of 5 amps to the MAXXFAN. Confirm that the circuit you intend to use will accommodate the additional load. Use the proper gauge stranded wire for electrical connections.

WARNING! To reduce risk of fire, injury to persons or damage to property, use only in the manner intended by AIRXCEL, INC. Should you have questions, please contact your AIRXCEL/MAXXAIR Distributor.



MAXAIR
VENTILATION SOLUTIONS

"More information <https://www.caravansplus.com.au>"

P/N: 11-9000KI
REV NEW, 05-08-2015

INSTALLATION INSTRUCTIONS - ALL MODELS

STEP 1

MAXXFAN requires a 355mm x 355mm roof opening, if you are replacing another type already installed, remove the old existing roof vent. Remove all old roof sealant for a minimum of 50mm entirely around the roof opening.

Place the **MAXXFAN** into the roof opening and trace a pencil line around it to verify the clean seal area that will be required. Note that the **MAXXFAN** must be centered in the roof opening with the hinge of the lid facing the front of the vehicle.

CAUTION: When installing your **MAXXFAN**, only use a caulking/sealant compatible with the flange (plastic product) and the roof surface. DO NOT use materials containing solvents such as or similar to Xylene, Toluene, Methyl Ethyl Ketone, Acetate or Acetone as they can damage the flange. Also, Polysulfide (Thiokol) type sealants must be avoided.

If in doubt, please contact the manufacturer of your Caravan for further information.

STEP 2

Prior to installing the **MAXXFAN** into the roof opening, apply a continuous strip of BUTYL tape or equivalent caulking to the underside of the flange, making sure to cover the screw holes.

CAUTION: Disconnect main vehicle power before connecting 12 volt DC power to the **MAXXFAN**!



STEP 3

Using the insulated 16 gauge electrical connectors provided, connect the vehicle's 12 volt power to the two **MAXXFAN** power wires.

CAUTION: Connecting the MAXXFAN to a circuit other than 12 Volts DC or with incorrect polarity could damage the MAXXFAN, cause injury to persons or damage to property and void the warranty.

NOTE: The **MAXXFAN** black wire identified with a tag showing (+) must be connected to the vehicle 12 volt (+) positive supply.

STEP 4

Insert the **MAXXFAN** into the opening with the lid hinge facing the front of the vehicle and centering the **MAXXFAN** in the opening. Make sure the power wires slide to the interior and do not become entangled. Using the sixteen (16) screws provided, screw the flange to the roof at each dimple location along the flange. Screw into the dimple to pierce the flange, making sure not to overtighten the screws to avoid cracking the flange.

STEP 5

After the **MAXXFAN** has been installed, remove the excess caulk that may have squeezed out. Using a sealer such as Dicor self-leveling lap sealant or similar caulking, apply a daub over every exposed screw head. In addition, apply a bead (approximately 5 mm) along the outside edge of the flange all the way around the vent.

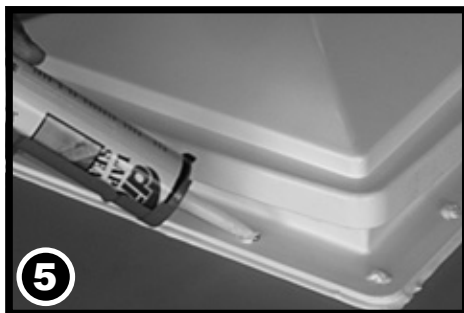

THIS COMPLETES THE ROOF TOP PORTION OF THE INSTALLATION

NOTE: Re-apply 12 volt vehicle power. The **MAXXFAN** will emit a beeping sound to indicate power is properly connected. In addition, the 4500KI and 4540KI Remote Control Models will automatically close the vent cover. If the **MAXXFAN** does not beep when power is connected, go back to step #3. Confirm that proper connections were made and 12 volt power is on and available. This **MAXXFAN** incorporates a self-resetting fuse on the circuit board located in the ceiling assembly. It can be reset by removing and re-applying power. If your fan fails to operate or needs reset, contact your AIRXCEL / MAXXAIR distributor for assistance or solicit the aid of an electrical technician.

FOR REMOTE CONTROL MODELS: Please refer to the REMOTE CONTROL OPERATING GUIDE in this manual for use and testing of your remote control. Install the two AAA batteries included, follow instructions, aim remote at the ceiling unit and test your fan. The Remote Control comes with a cradle for wall mount storage of the Handheld Remote Control. Mount the cradle to your wall using the screws provided.

"More information <https://www.caravansplus.com.au>"

STEP 6

The interior Garnish Trim Ring must be trimmed to fit your particular Caravan roof thickness. To accomplish this, measure the distance from the vehicle ceiling surface to each corner of the **MAXXFAN** Control Plate.

Most Caravan roofs have some slope, so measuring each corner is necessary. The Garnish ring should be cut 6mm to 12.5mm longer than the dimensions measured at each corner.

In Picture #6 to the right, the installation measures 90mm from the ceiling (this is an example only) to the Control Plate. After adding 12mm as in this example, using a ruler, place a mark at 102mm on each corner of each side of the Garnish Ring (refer to 6A below). Once marked, draw a line connecting all 102mm markers on the outside of the Garnish ring and trim accordingly (refer to 6B to the right).

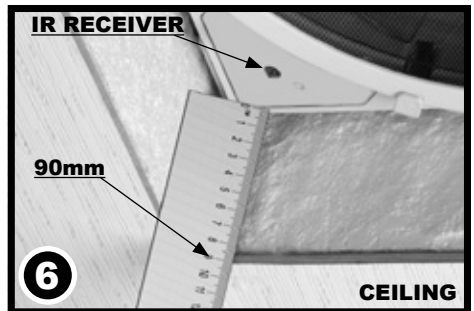

NOTE: DO NOT probe or tamper with the thermostat sensor or IR sensor shown in illustration #6 above.



**MEASUREMENTS STATED
IN STEP 6 ARE USED AS AN
EXAMPLE FOR ILLUSTRATION
PURPOSES ONLY**

STEP 7

Complete the installation by placing any excess wiring to the inside of the roof opening and sliding the Garnish Ring into position. Fasten in place by using the four painted flat head screws provided.



CONGRATULATIONS!!!

You have successfully completed the installation of your new **MAXXFAN**. If you have questions, please visit www.Airxcel.com or contact your **AIRXCEL / MAXXAIR Distributor**.

"More information <https://www.caravansplus.com.au>"



FOR REMOTE CONTROL MODELS:

Attach the included cradle to wall with (2) #6 screws provided. Handheld Remote Control may be placed into wall cradle for storage.

MAXXFAN® 1 YEAR LIMITED WARRANTY

AIRXCEL, INC. - RV PRODUCTS DIVISION / MAXXAIR Ventilation Solutions warrants to be free of manufacturing defects, regardless of ownership for a period of one (1) year from the original date of purchase. **You must keep your original sales receipt.** This **Limited Warranty** does not include "Acts of God," failure due to misuse, improper installation or accidental / incidental damages. Please call your AIRXCEL / MAXXAIR Distributor if you have any questions or need assistance. **Please have your original sales receipt and MAXXFAN Serial Number readily available.** This limited warranty does not cover labor or any freight costs for the return of the product to or from AIRXCEL, INC. or costs associated with installation, removal or reinstallation of the product.

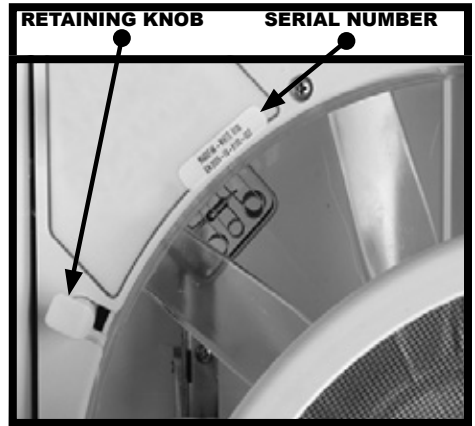

For WARRANTY INFORMATION on products purchased in Australia or New Zealand, please visit www.coastrv.com.au • www.coastrv.co.nz

The Serial Number for your MAXXFAN is located on the fan control plate under the round insect screen frame. Actual location may differ from image shown. Reference your operating guide. Rotate the four retaining knobs 180° and remove the screen to view. DO NOT OPERATE the MAXXFAN with the screen removed.

CAUTIONS AND CARE OF YOUR MAXXFAN®

This product has been manufactured using prime UV stabilized Polymers for maximum toughness and durability. However, the use of caustic or solvent based chemicals can cause cracking and product failure.

PLEASE CLEAN ALL PARTS WITH MILD SOAP AND WATER ONLY.

Do not use Petroleum Containing Additives or Solvent Based Products on any of the MAXXFAN's components or its corrosion resistant hardware.

LISTED BELOW ARE SOME KNOWN CHEMICAL PRODUCTS TO BE AWARE OF:

NON COMPATIBLE CHEMICALS - DO NOT USE THESE:

Ketones, Esters, Acetone or other like solvents, Halogenated Hydrocarbons, Amines, Aromatic Hydrocarbons, (Loctite Formulas), or any products containing references to: chemicals that are not to be used on plastics.

GENERALLY COMPATIBLE (But should be used in low concentration where possible)

Acids, Alcohol, Alkalis, Aliphatic Hydrocarbons, Mild Soap Solution (avoid strong Alkaline Material), Silicone Oil or Greases (avoid those containing Aromatic Hydrocarbons or other additives). Review the contents of your cleaning materials carefully.

*For additional information regarding your **NEW MAXXFAN Plus**, please refer to the **INFORMATION AND OPERATING GUIDES** for your particular model on the following pages.*

INFORMATION AND OPERATING GUIDE

FOR MAXXFAN® Plus MODELS

4000KI • 4500KI • 4540KI

KNOB, VENT LID OPEN/CLOSE

Manual Opening Models

Pull to unlock prior to turning. Rotate Knob clockwise to Close Vent Lid; Rotate Knob counter-clockwise to Open Vent Lid. Push "IN" to lock when Vent Lid is open or closed.

Automatic Opening Models

Allows closing of the vent lid in the event of Caravan power loss. This knob does not lock. Do not push in or pull out. Rotate knob clockwise to close vent lid; rotate knob counter-clockwise to open vent lid.

Do not use excessive force when operating Knob.

KEYPAD CONTROLS

Use Keys on Keypad to control MAXXFAN functions (see descriptions on next page).

INSECT SCREEN RETAINER KNOB

Rotate all 4 knobs 1/2 turn to remove screen.



THERMOSTAT TEMPERATURE SENSOR

CAUTION: *Never operate fan with screen removed. When removing screen for cleaning, turn the MAXXFAN OFF and remove the vehicle 12 volt power to the MAXXFAN. When cleaning your MAXXFAN, use only a mild detergent solution.*

RAIN SENSOR - 4500/4540 MODELS ONLY - If the Rain Sensor circuit detects moisture, it will TURN OFF the fan and close the lid. If ANY key is pressed when the Rain Sensor is still wet, the fan will BEEP THREE (3) TIMES. Press the FAN ON/OFF key to restart the fan after the Rain Sensor has dried.

CAUTION: *If the lid is opened MANUALLY, the RAIN SENSOR will not close the MAXXFAN lid.*

CEILING FAN MODE

With the fan motor running, close the Vent Lid to enter Ceiling Fan Mode. The fan motor will continue to run and circulate air within the Caravan cabin.

SERIAL NUMBER LABEL

The serial number label is located underneath the round insect screen.

NOTE: The MAXXFAN is designed to be fully opened or fully closed when the vehicle is moving.

KEYPAD CONTROLS FOR MAXXFAN® Plus MODELS 4000KI • 4500KI • 4540KI

NOTE: A beeping sound will confirm each key press

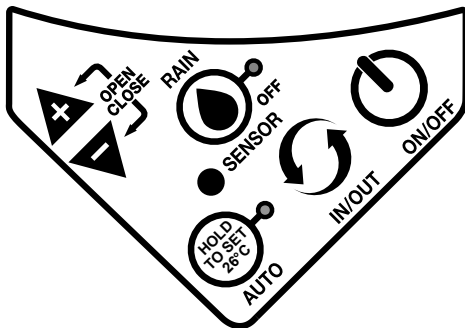

ON/OFF

ON/OFF: Use this key to start the fan or to turn off the fan. On Automatic Opening Models, the lid will also open or close when the fan is turned on or off. On Manual Opening Models, pushing this key while in Auto Mode will exit Auto Mode, turn off the fan and the lid will stay in the position you selected. On Automatic Opening Models, this button will exit Auto mode, turn the fan off, and close the lid.



IN/OUT

IN/OUT: Use this key to reverse the direction of the fan, the fan will slow down and pause for two (2) seconds before resuming operation in the opposite direction. **Note:** In Auto Mode the fan direction is automatically positioned to Exhaust, but may be overridden and changed to Intake by depressing this key. **Note:** Some models are Exhaust Only. On these models this key is deleted.



AUTO

AUTO: Auto Mode allows the thermostat to turn the fan **ON and OFF** depending on the thermostat setting. Press this key once for less than three (3) seconds to enter Auto Mode, three (3) quick beeps will confirm the MAXXFAN has entered Auto Mode. To EXIT Auto Mode, press the **ON/OFF** key. Initial factory set point for the thermostat is 26°C. The green LED will light to indicate the MAXXFAN is in Auto Mode. To adjust, follow instructions below:

If no previous thermostat temperature was entered, or you wish to change a previous set temperature, press the HOLD TO SET key for more than 3 seconds and you will hear one long beep and the thermostat will be reset to 26°C. To further adjust the set temperature, if desired, use the (+) or (-) Arrow keys to adjust at 0.5°C per press. The fan will emit a beeping sound to confirm this setting. If a previous thermostat temperature was entered, the fan will remember this temperature setting and the next time you enter Auto Mode, the fan will start ventilating automatically as directed by the thermostat. The fan speed will automatically adjust based on the cabin temperature. As cabin temperature rises, the fan increases in speed. **Note:** If 12 volt Caravan power is removed from the MAXXFAN, the thermostat will be reset to 26°C.



ARROW

When in Auto Mode: Use the (+) & (-) Arrow keys to adjust the thermostat set temperature up or down by 0.5°C per press.

When in Manual Mode: Use the (+) & (-) Arrow keys to adjust the fan speed up or down. When the fan speed reaches either the maximum or minimum speed, the fan will respond with 2 quick beeps to indicate this.

ARROW KEYS PRESSED TOGETHER: *Automatic Lift Models Only*

Press the (+) & (-) Arrow keys at the same time to Open or Close the lid. The fan motor will remain in its current state.



RAIN SENSOR

RAIN SENSOR: *4500/4540 Models Only*

Press this key to turn the Rain Sensor OFF. This will deactivate the Rain Sensor. The red LED will light to indicate that the Rain Sensor is deactivated. Use caution when deactivating the Rain Sensor as rain could enter your Caravan. If the Rain Sensor circuit detects rain, it will turn off the fan and close the lid. The red LED will blink to indicate that the Rain Sensor has shut the fan off. Press the Rain Sensor key again to reset the fan and extinguish the blinking LED. **Note:** CAUTION: the Rain Sensor will not close the MAXXFAN lid if the lid is opened manually with the knob.

REMOTE CONTROL OPERATING GUIDE

WIRELESS REMOTE CONTROL FOR MAXXFAN® Plus MODELS: 4500KI • 4540KI



ON/OFF

FAN ON & POWER OFF - Press this button:

- To start the fan
- To turn the fan off
- To exit Auto Mode

Remove protective film from Display Screen



VENT
OPN/CLS

VENT LID POSITION - Press this button to open or close the vent lid

- While the fan is running in Manual Mode press once to close the vent lid and enter "Ceiling Fan" Mode.

NOTE: This button is not active in Auto Mode. If the fan loses 12volt Caravan power or power is removed from the fan, use the knob located at the ceiling to manually open or close the vent lid if desired.



AIR
IN/OUT

AIR EXHAUST / INTAKE - Press this button to reverse the fan from intake or exhaust

NOTE: In Auto Mode, the fan direction is automatically positioned to Exhaust, but may be overridden and changed to Intake by depressing this key.



AUTO
ON/OFF

FAN AUTO MODE - Press this button to enter Auto Mode

- Auto Mode allows the fan lid to automatically open and the fan motor to operate as dictated by the thermostat set point temperature. Once the cabin temperature cools and reaches the set point temperature, the fan lid will close and the fan motor will shut off.
- Pressing this button while in Auto Mode will shut off Auto Mode, close the vent lid and shut off the fan motor.



TEMP+

THERMOSTAT SET TEMPERATURE

TEMP + ~ Press this button to increase the Set Temperature for Auto Mode.

TEMP - ~ Press this button to decrease the Set Temperature for Auto Mode.

NOTE: The thermostat temperature range is from -2°C to 37°C. To change from Celsius to Fahrenheit on the temperature display, press and hold both set temperature keys simultaneously.



TEMP-



SPEED+

FAN SPEED

Fan Speed + ~ Press this button to increase the fan speed.

Fan Speed - ~ Press this button to decrease the fan speed. The fan has ten speeds.

NOTE: When the fan speed reaches either the maximum or minimum speed, the fan will respond with 2 quick beep sounds to indicate this.



SPEED-



LOW BATTERY INDICATOR

- When the battery is at full charge, three black power bars are displayed.
- One or zero power bars displayed indicates the batteries need replacement.



TRANSMISSION SIGNAL

- This symbol is displayed on the screen when any button is pressed to indicate the signal was transmitted to the fan.
- A beeping sound from the ceiling unit indicates the signal from the remote control was received by the fan.

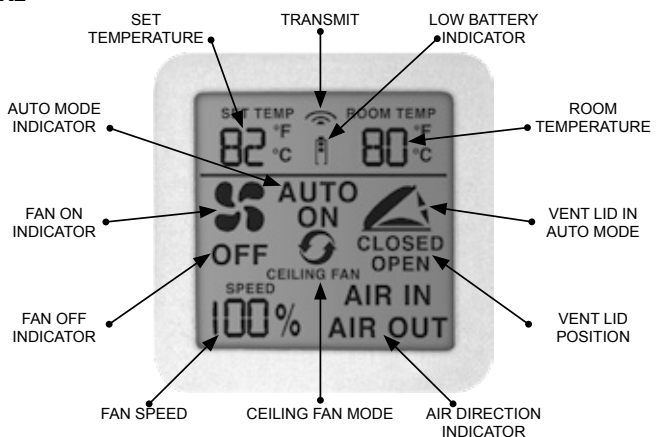

ENJOY your new **MAXXFAN®** in all weather conditions with the **NEW FANMATE®** FEATURING **EZClip™** Hardware

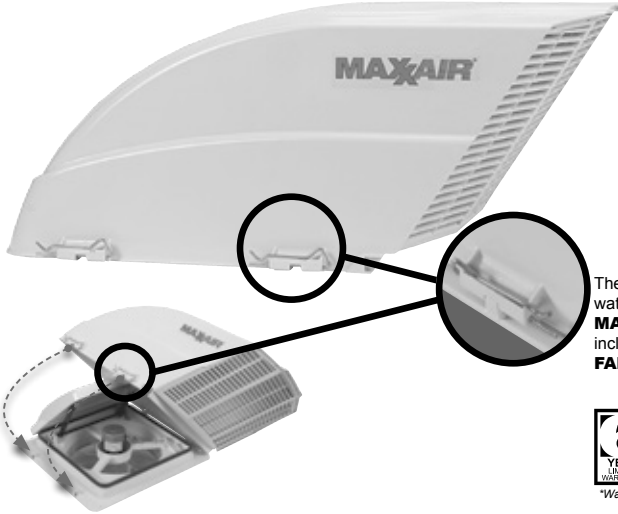

- ▶ **SUPERIOR** rain protection
- ▶ **LESS** than 5% airflow restriction
- ▶ **UNIQUE** design allows for use on ANY high powered or non-powered ceiling fan or vent
- ▶ **OPTIONAL** bug screen
- ▶ **FULL ACCESS** to the fan and optional bug screen courtesy of the EZClip™

EZClip™

QUICK, EASY and TOOL-FREE INSTALLATION

The **FANMATE** simply fits over the molded, waterproof mounting tabs built into YOUR **MAXXFAN** Standard. Simply **SLIDE** the included clip through the tab to secure the **FANMATE** cover. **FRESH AIR, RAIN OR SHINE!**



*Warranty limited to repair or replacement, see Airxcel.com for details.

OTHER GREAT PRODUCTS FROM MAXXAIR®

MAXXFAN® Deluxe
with **BUILT-IN RAIN SHIELD**

- Features a powerful 10-speed fan motor
- Provides over 900 CFM to keep you cool and comfortable
- Backup controls at ceiling - **A MAXXFAN Exclusive!**
- Ceiling Fan Mode
- Flush mounted, easy to clean Keypad controls fan speed, thermostat, air intake and exhaust
- Installs into 355mm x 355mm Caravan roof openings
- Models available for 400mm x 400mm Caravan roof openings

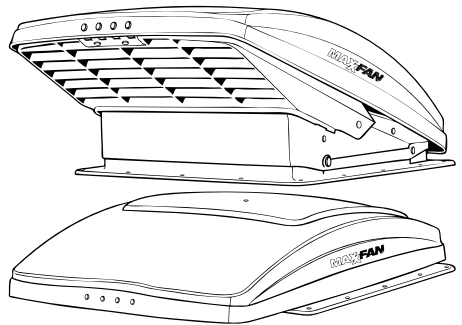

AVAILABLE IN MANUAL OR ELECTRIC REMOTE OPENING MODELS

12V		 Electric or Manual Opening OPTIONAL			 THERMOSTAT CONTROL	 MODELS 7000, 7200
------------	--	--	--	--	---------------------------	-----------------------

For additional product information please visit www.AIRXCEL.com

AIRXCEL, INC. - RV Products Division / MAXXAIR
3050 N. St. Francis St. • Wichita, KS 67219 • USA



"More information <https://www.caravansplus.com.au>"