

WINEGARD[®]

Sensor[™] HV

VHF & UHF Antenna



Coast to Coast RV Services

20 George Young Street, Auburn NSW 2144

Postal Address: PO Box 415, Regents Park NSW 2143

Phone: 02 9645 7600

Fax: 02 9645 7688

Email Technical: technical@coastrv.com.au

Email Warranty: warranty@coastrv.com.au

Specifications

- For VHF & UHF channels
- Bidirectional antenna
- Operating dimensions: 43.2 cm wide x 116 cm tall
- Length when stowed: 125.3 cm
- Height when stowed: 11.2 cm
- Storage (survival) temperature: -40° C to +80° C
- For outdoor use only
- Model CC-10HV (Aftermarket)

Product Registration

Please register your Winegard product by completing the online registration form at <http://www.winegard.com/registration>.

Front of Antenna

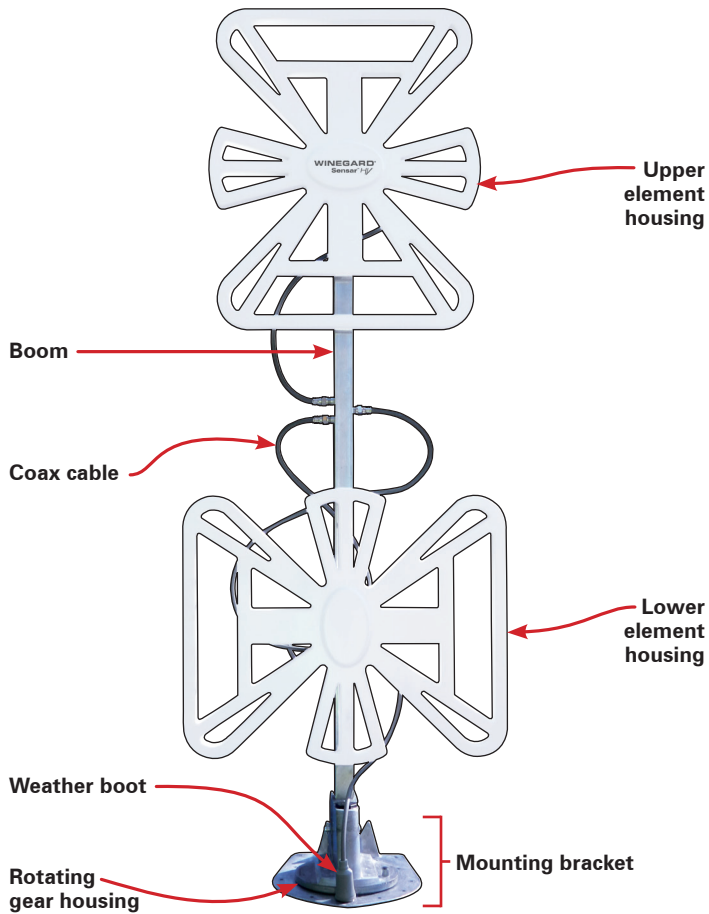

Mounting Bracket

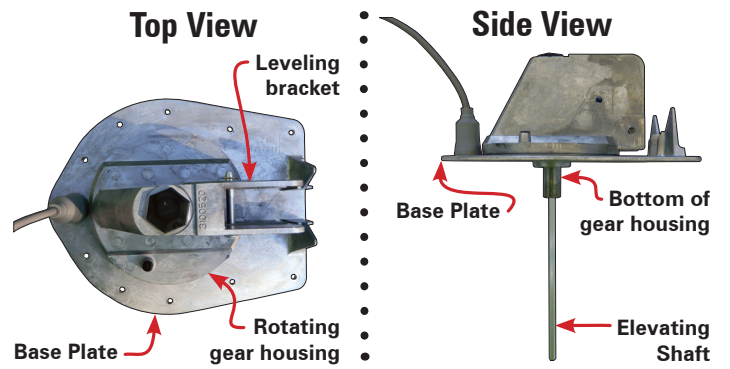

Other Hardware

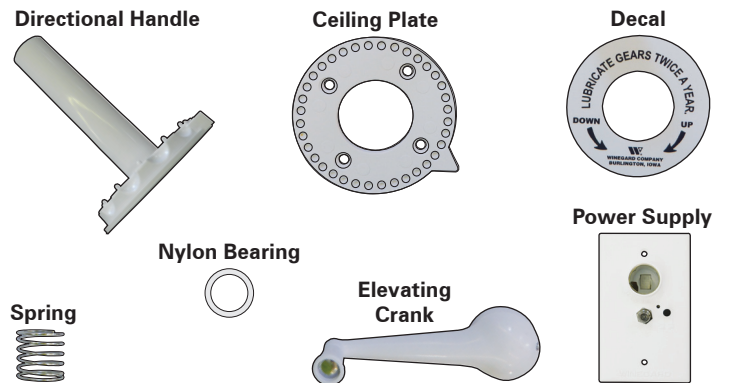

Clearance Requirements

The Winegard Sensor HV antenna requires a minimum roof space of 125.3 cm x 43.2 cm for the stowed antenna.

When stowed, the top of the element housing rests 11.2 cm above the roof.

The antenna requires a clearance radius of 115.6 cm for the antenna to raise to the vertical position.

Maintain a minimum distance of 26 cm from the nearest obstruction and from the edge of the roof.

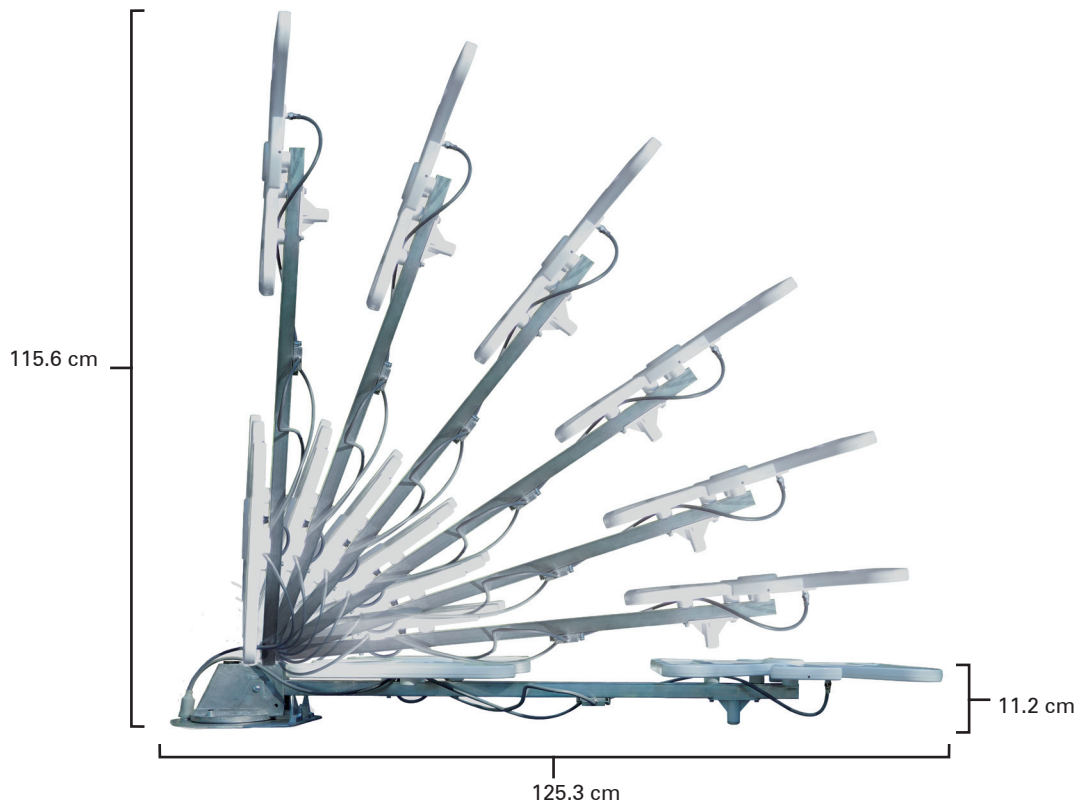

Choosing a Location for the Antenna

 Install in dry conditions only!

Before choosing a location for the antenna, contact your RV dealer or manufacturer. Your RV may be pre-wired or have a reinforced area for this system.

When choosing a location for the antenna, keep in mind that the antenna must be mounted on or parallel to the centerline of the coach with the front of the antenna (the mounting bracket) facing the front of the RV.

NOTE The antenna is shown in the travel/stowed position.

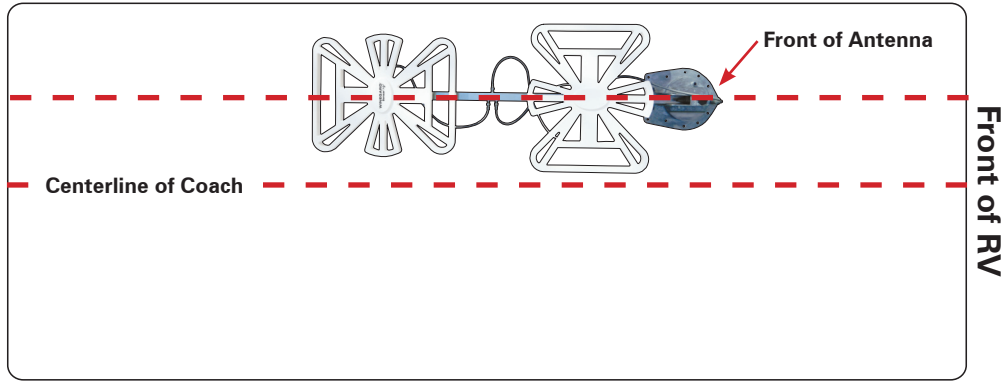

Choose a location on the roof of the RV that meets the following requirements:

- 1 Offers enough support for a secure installation
- 2 Has a minimum roof space (clearance) of 125.3 cm x 43.2 cm for the stowed antenna
- 3 Allows antenna to raise and rotate without interference from other roof-mounted equipment
 - clearance distance of 61 cm from antenna to the front of the vehicle
 - clearance radius of 116 cm needed for antenna to raise to vertical position
 - clearance distance of 26 cm needed from antenna to nearest obstruction and to the edge of the roof

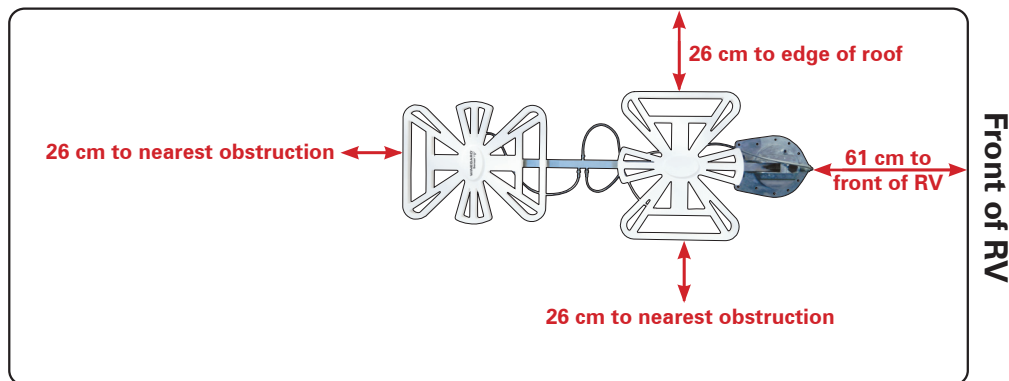
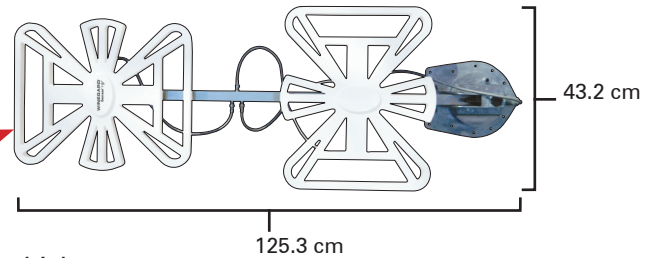

- 4 Is within five degrees of level (for best operation, must be within three degrees of level)

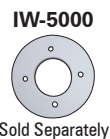

- For sloped/rounded roofs, Winegard recommends model RW-2000 exterior roof wedge (sold separately) to level installation.
- An interior wedge IW-5000 (sold separately) is also available.

Making Cable Entry Holes

- 1 The ceiling plate will be mounted inside the vehicle directly underneath the mounting bracket. Make sure the ceiling area is clear underneath the chosen location for the mounting bracket.
- 2 Use the template on the last page of this manual, and drill a 4.5 cm hole through the roof and ceiling of the vehicle. Be careful not to damage any wiring between the roof and ceiling when drilling.
- 3 Using the template on the back page, drill a 13 mm hole for cable entry through the roof of the vehicle only. Do not drill through the ceiling!

Assembling the Antenna

- 1 Pull the e-clip off of the pin, and remove the pin from the leveling bracket. Set the e-clip and the pin aside—you will need these later.



NOTE An extra e-clip has been provided, which is in a bag attached to the back of the boom.

- 2 With the elements on top of the boom, insert the elevating gear in-between the sides of the leveling bracket. The holes in the sides of the leveling bracket and the elevating gear should align.

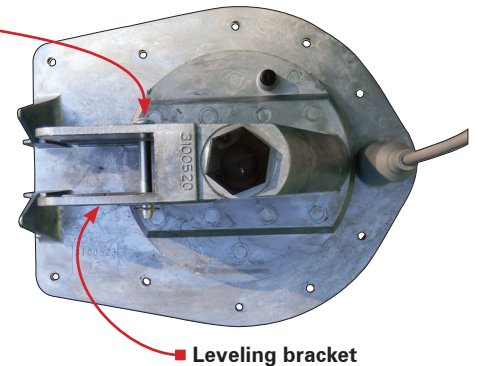
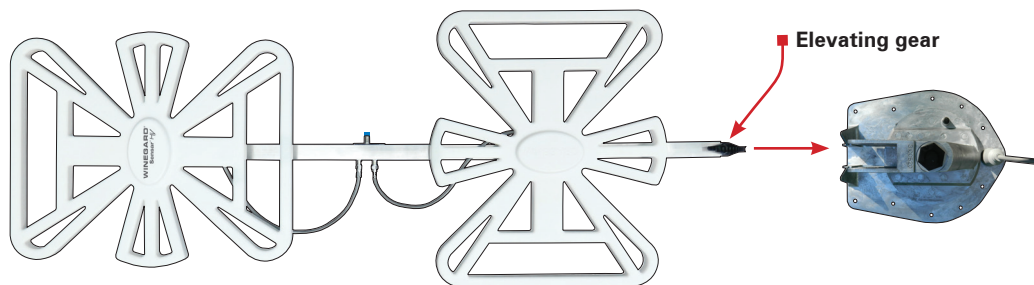

- 3 Insert the pin through the leveling bracket and the elevating gear. Push the e-clip over the end of the pin.

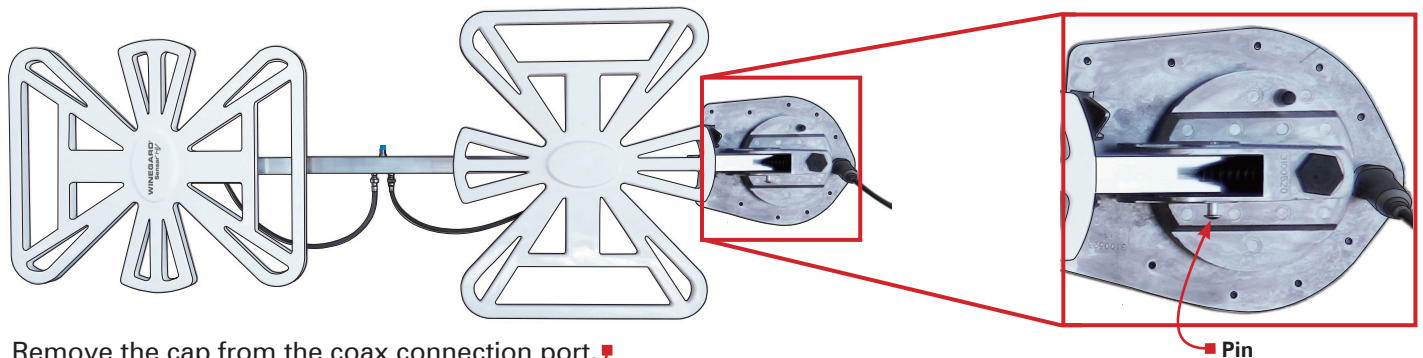

- 4 Remove the cap from the coax connection port.

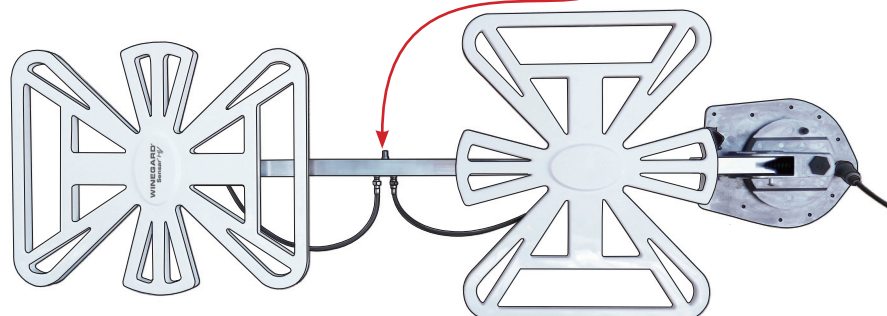

Assembling the Antenna, Cont.

- 5** Thread the 140 cm coax between the boom and the center of the bottom element housing.

- 6** Continue to thread the coax in an S-curve between the boom and the bottom element housing.

- 7** Connect the coax to the coax connection port, and tighten until fingertight. Then, tighten $\frac{1}{4}$ turn more.

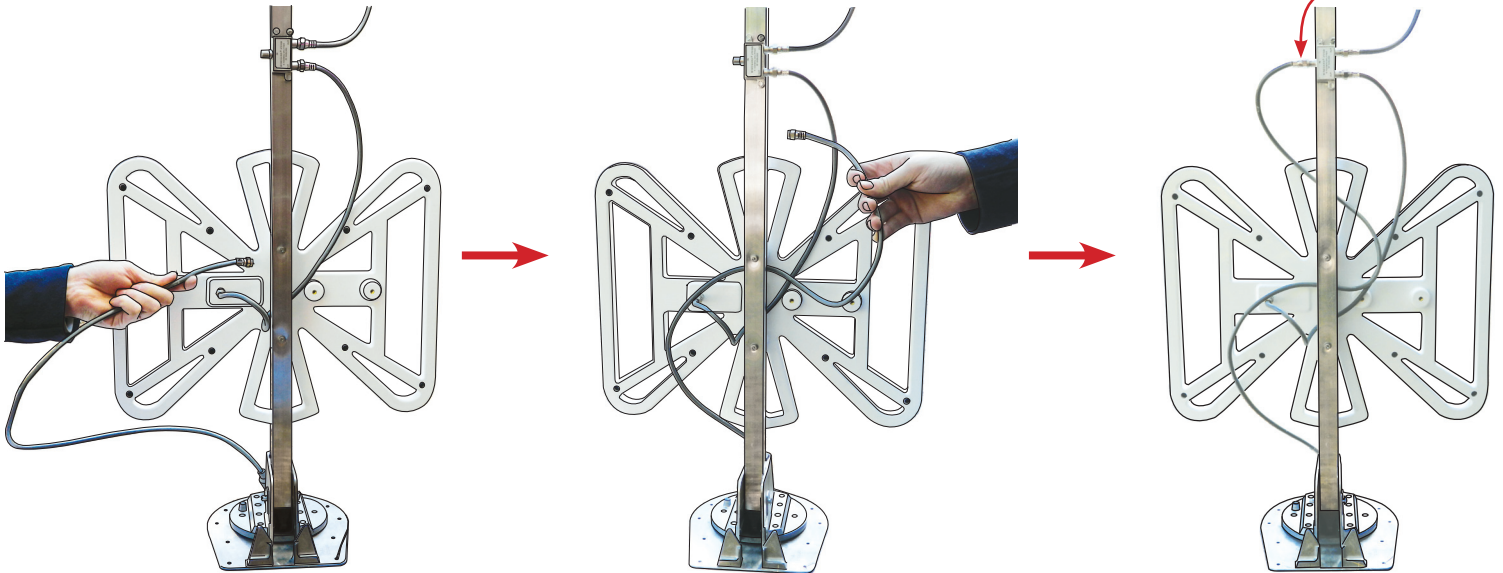

- 8** Connect the other end of the 140 cm coax to the 6.1 m coax using a barrel connector, and route the 6.1 m coax to the location of the power supply.

Installing the Mounting Bracket

- 1** If using a roof wedge or interior wedge, put in place before proceeding to install the base plate or interior hardware.
- 2** Center the elevating shaft in the 4.5 cm diameter hole. Check with your vehicle manufacturer to determine if the provided screws are suitable for your roof. Temporarily secure the base plate to the roof with two of the provided screws. Check that the weather boot is in place over the boot collar.
- 3** Make sure the antenna is in the chosen location. The antenna should be in the stowed/travel position. The coax cable should be routed through the ceiling and wall to the power supply.
- 4** Apply a liberal amount of approved nonhardening sealing compound on the bottom of the base plate. This will help to prevent leaks.

 Do not get sealing compound on bearing surface between base plate and rotating gear housing.

 Do not paint the top of the base plate or around the rotating gear housing.

- 5** Using the provided screws, secure the base plate to the roof. Run a solid bead of sealant over the mounting screws. This will also help to prevent leaks.

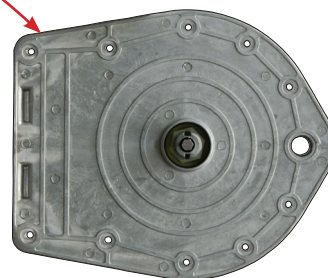
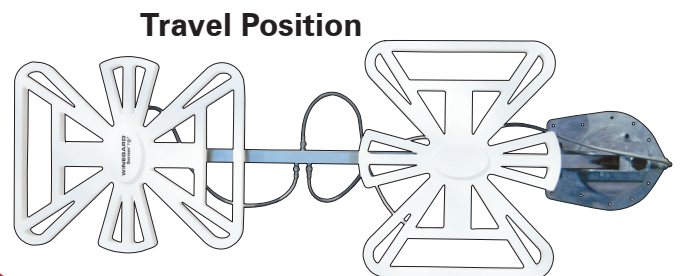

TIP Run sealant around the holes for the mounting screws, around the hole for cable entry, and around the bottom gear housing.

Cutting the Directional Handle to fit Roof Thickness

- Determine the roof thickness. The mount is designed to fit roofs from 2.5 cm to 12 cm thick.
 - If the roof is less than or equal to 12 cm thick, continue to step 2.
 - If the roof is more than 12 cm thick (max. 17.8 cm), a directional handle extension is needed. Winegard recommends model EK-1036 directional handle extension (sold separately).

EK-1036



Sold Separately

- Inside the vehicle, mark the elevating shaft 3.8 cm below the ceiling. Cut the shaft on this mark.

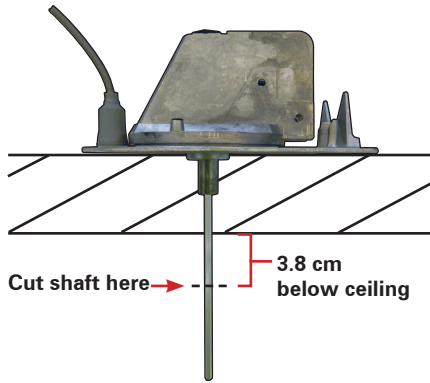

- Push the directional handle up into ceiling and over the shaft.

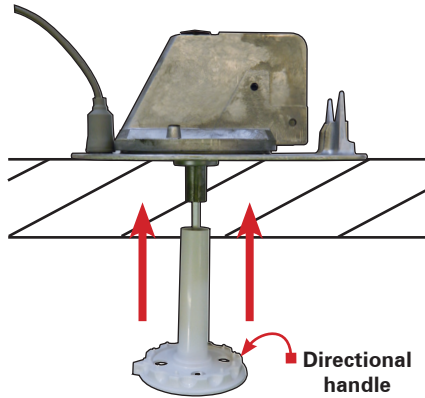

- Carefully align the keys inside the directional handle with the keyways on the bottom of the gear housing. (The keys only line up one way—do not force.)

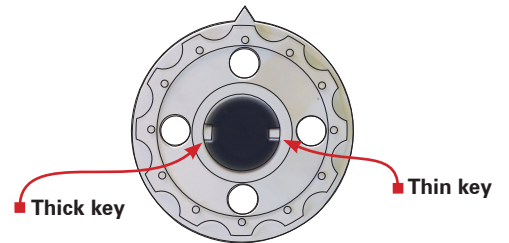

- Make sure the top of the directional handle is snug against the bottom of the base plate.



- Measure the distance between the bottom of the recess on the handle to the ceiling.

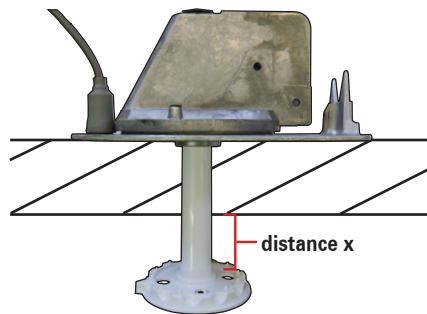

- Pull the handle down, and transfer this dimension to the shaft end of the directional handle. Mark this, and cut the handle at the mark.

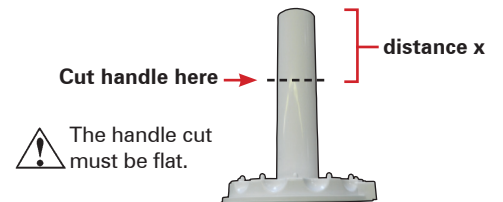

TIP The pointer on the handle should point toward the back of the coach.

Installing the Crank Assembly

- Lay the ceiling plate on top of the directional handle with the pointers aligned.

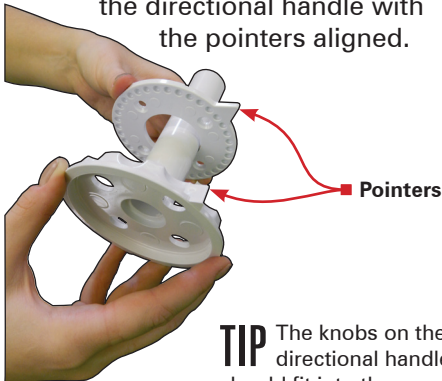

TIP The knobs on the directional handle should fit into the grooves on the ceiling plate.

- Slide the ceiling plate and directional handle assembly over the rotating base shaft.

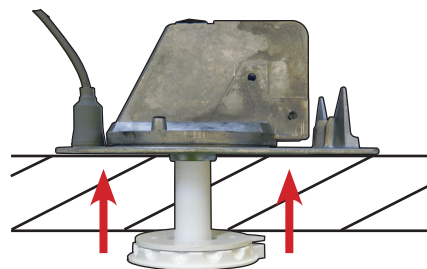

- Make pilot holes in the ceiling. Then, mount the ceiling plate with the four provided screws.

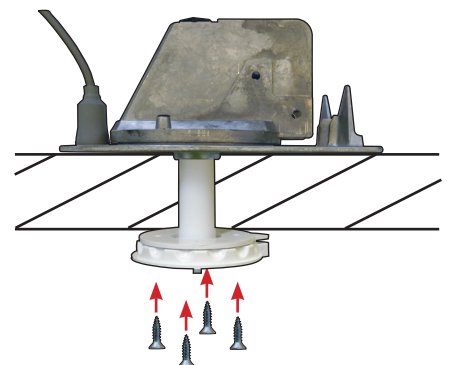

Installing the Crank Assembly, Cont.

- 4** Remove the backing from the decal, and place the decal on the bottom of the directional handle.

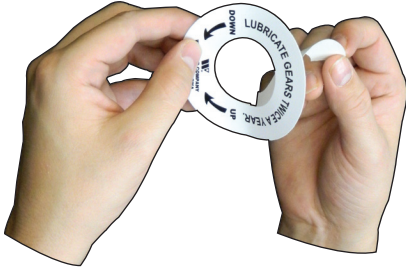

- 5** Slide the spring over the rotating base shaft.

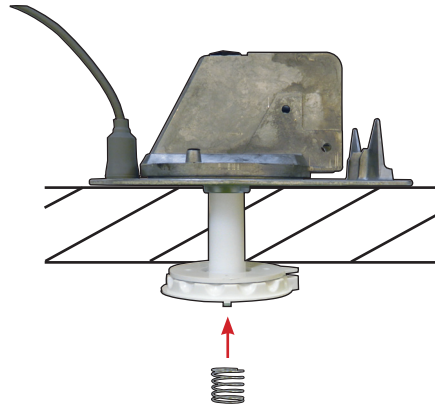

- 6** Place the nylon bearing over the top of the crank.

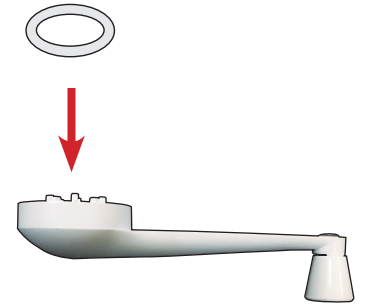

- 7** Slide the elevating crank (with nylon bearing on top) onto the rotating base shaft.

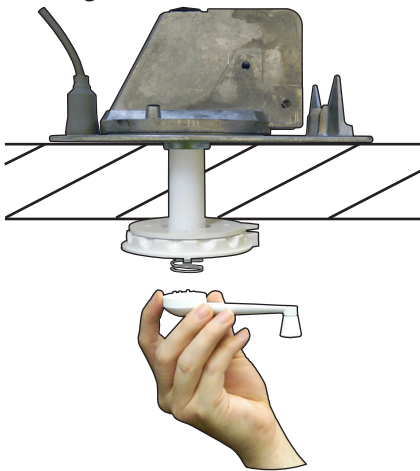

- 8** Check that the set screw lines up with one of the flat sides of the rotating base shaft.

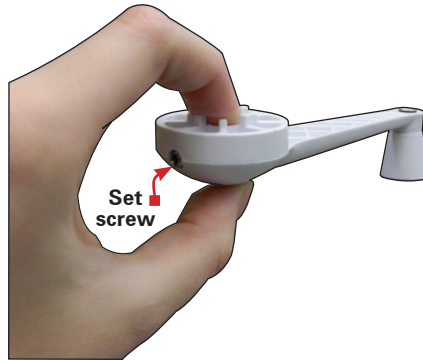

- 9** Tighten the set screw until it touches the rotating base shaft. **Then, tighten only 1/4 turn more.**

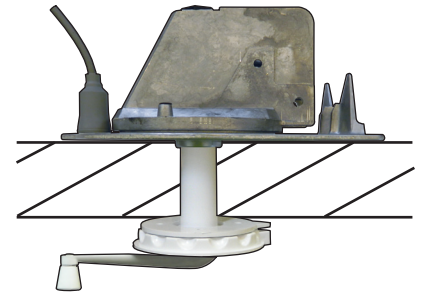

NOTE The set screw simply holds the elevating crank to the rotating base shaft.

Installing the Power Supply

The power supply may be flush mounted in most standard electrical boxes. To flush mount, cut a hole in the wall to fit the box. Run two #12 wires between the wall plate and +12 VDC source, and route download cable to this location.

Front of Power Supply

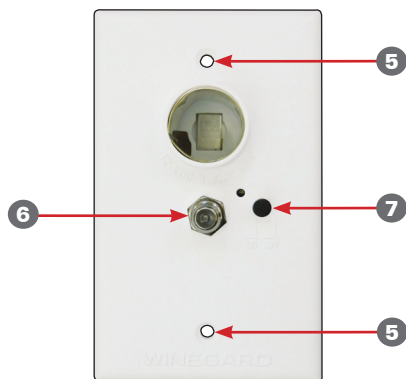

Back of Power Supply

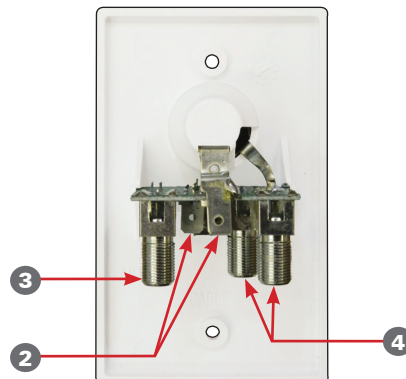

 Do not connect high current devices such as hair dryers to this receptacle. Maximum current rating of receptacle is 8 amps at +12 VDC.

 The power supply should be turned off when connecting cables/wires.

- 1** Select a location for the power supply.

- 2** Make 12 volt connection to the power supply. Install terminals on wires from +12 VDC source, and crimp the terminals with an appropriate crimping tool. If in doubt as to the polarity of the wires, connect them temporarily to the tabs, and press the "ON" switch on front of wall plate; if light comes on, polarity is correct. Turn power off.

Installing the Power Supply, Cont.

- 3 Connect the coax cable from the antenna to the "ANTENNA" port on the power supply, and tighten until fingertight. (The coax cable should have been routed through the ceiling and wall to the chosen wall plate location.) If the connector is removed before routing the coax cable, see page 9 for help re-installing the connector.
- 4 If hooking up the antenna to a second television, connect another coax cable from the "SET 2" port on the back of the power supply to the "Antenna In" port on the second television. If hooking up a cable input, connect the cable from the cable input to the "CABLE" port on the back of the power supply.
- 5 Mount the power supply in wall with the provided screws.
- 6 Connect the 72" coax cable from the coax port on the front of the power supply to the "Antenna In" coax port on the TV.
- 7 Press the "ON" switch on the front of the power supply, and check that the light is on.

Operation

1 Raising Antenna

Turn the elevating crank clockwise in "UP" direction about 13 turns or until some resistance to turning is noted.

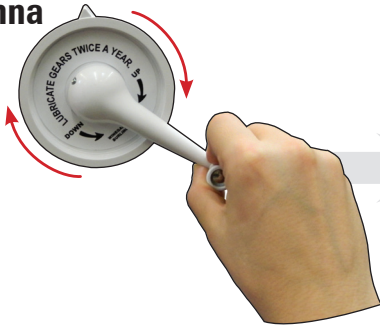

2 Turning on Power Supply

Turn power supply on to use either front or rear output of the TV outlet. Neither outlet will work unless the power supply switch is on.

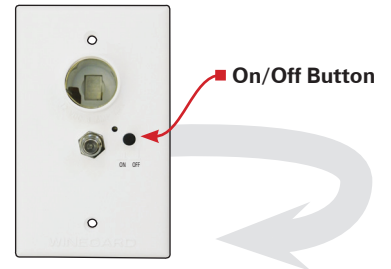

3 Rotating Antenna for Best Picture

Make sure the antenna is in the "UP"/deployed position. Pull down with both hands to disengage ceiling plate. **For analog signals, rotate for best picture. For digital signals, run a channel scan to find the best signal.**

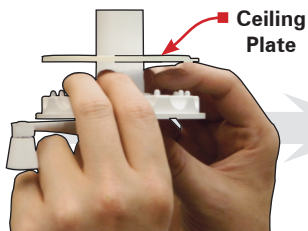

4 Lowering Antenna to Travel Position

Rotate the antenna until the pointer on the directional handle aligns with the pointer on the ceiling plate. Turn elevating crank counterclockwise in the "DOWN" direction about 13 turns or until some resistance is noted. The antenna is now in the travel position.

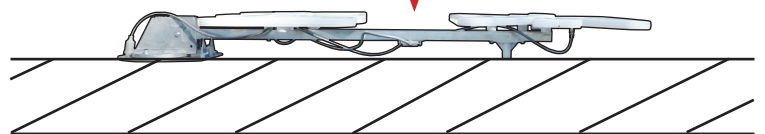

NOTE Antenna reception may vary based on transmitting antenna tower height, lobe pattern of the transmitter, height of the receiving antenna, weather conditions and terrain on receiving path including trees, buildings and hills.

! Lower the antenna to the travel position before traveling!

Do

- 1 Check parking location for obstructions before raising the antenna.
- 2 Carefully raise, lower, and rotate the antenna. If having trouble, check for obstructions.
- 3 Rotate slowly when selecting a station, and check the fine-tuning on the TV.
- 4 Lower the antenna to the travel position before moving the vehicle.

Don't

- 1 Don't force the elevating crank up or down or rotate the directional handle hard against stops.
- 2 **Don't travel with the antenna in the up/deployed position. Stow the antenna before traveling or when wind speeds reach +113 km/h, or you will void your warranty.**
- 3 Don't leave the antenna partially deployed.
- 4 Don't apply sealant over the top of the base plate.

Checking the Operation of the Power Supply

- 1 Tune the television receiver to the nearest station, and rotate the antenna for the best picture and sound.
- 2 This unit is equipped with a polyswitch, a current limiting device, which will shut down +12 VDC if there is a direct short between the antenna and power supply. The green indicator light will not light. Once short is eliminated, the device will reset itself.

Maintenance

Lubricate gears 3–4 times a year for optimal performance.



 **Use silicone spray to lubricate gears. Never use WD-40 oil for it will damage the gears!**

3–4 times a year or in the event that rotating the antenna becomes difficult, use silicone spray to lubricate the elevating gear. Apply a liberal amount of silicone spray lubricant to the elevating gear. The lift should be in the down position. Then, run the lift up and down to distribute the lubricant over gears. (This is easiest if one person cranks up and down from inside the vehicle while another person sprays the gears.)

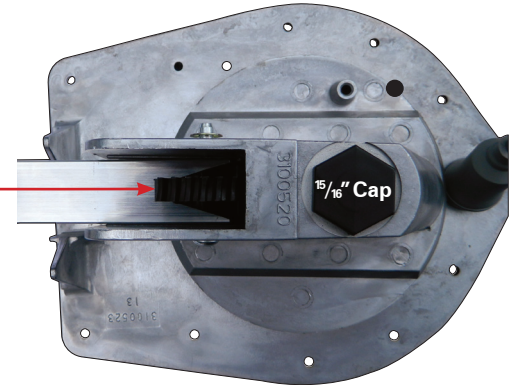
Lubricate here
around elevating
gear



Troubleshooting

-  Do not install couplers, splitters, etc. between the power supply and the antenna. Installation of any item on the download may cause a short in the system. The download supplies +12 VDC to the preamp in the antenna.
-  The power supply should be turned OFF when connecting/disconnecting cables to power supply and antenna but should be turned ON when testing for voltage.

Testing System

- 1 Make sure TV set is working properly.
- 2 Switch power supply ON and OFF while checking for difference in picture quality. If there is no difference, continue with step 3.
- 3 Disconnect the cable from the antenna, and check for +12 VDC at Test Point #1. If there is +12 VDC at Test Point #1, there may be a problem with the antenna.
- 4 If there is NO +12 VDC at Test Point #1, reconnect cable to antenna. Remove power supply from wall, and visually inspect for burned/broken parts. If there are ANY broken/burned parts, replace power supply.
- 5 Disconnect cable from antenna jack on power supply. Check for +12 VDC at Test Point 2. If +12 VDC is present, there is a problem with the cable connecting the power supply to the antenna. Repair/replace cable.
- 6 If +12 VDC is not present at Test Point # 2, be sure the green indicator light is ON. If not, check the polarity of the ground and +12 VDC source wires to make sure there are 12VDC present. If there is still no +12 VDC, replace power supply.

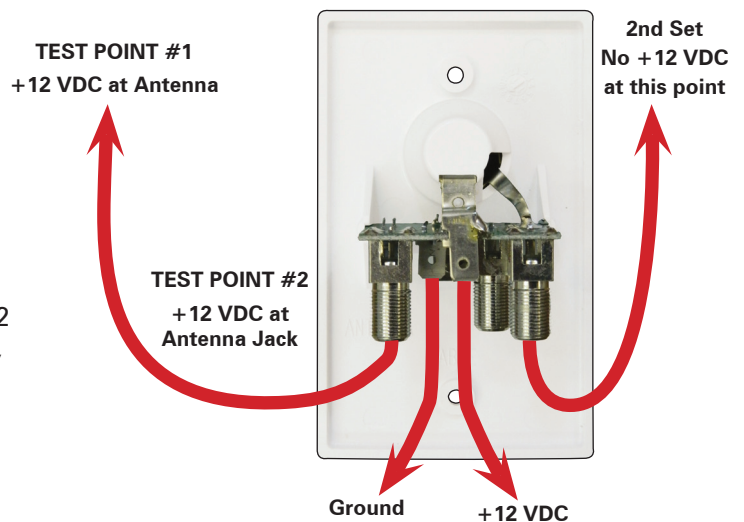

Installing Connector on Coax Cable

Tools Needed:

Cable stripper

Compression tool for compression connectors

Hex crimp tool for hex crimp connectors

Strip outer cover back 12 mm from end of cable.

Fray braid back as far as outer cover will allow.

Trim braid close to outer cover, and remove 6 mm of inner insulation, being careful not to nick the center conductor. Make sure no foil or braid can touch center conductor.

Slide connector tip between braid and inner insulation (braid and foil, on foil shield cable). Push connector on cable as far as it will go. Attach cable with proper crimping or compression tool. Do not crush cable out-of-round.

TIP If installing in hot weather, increase these dimensions 3 mm.

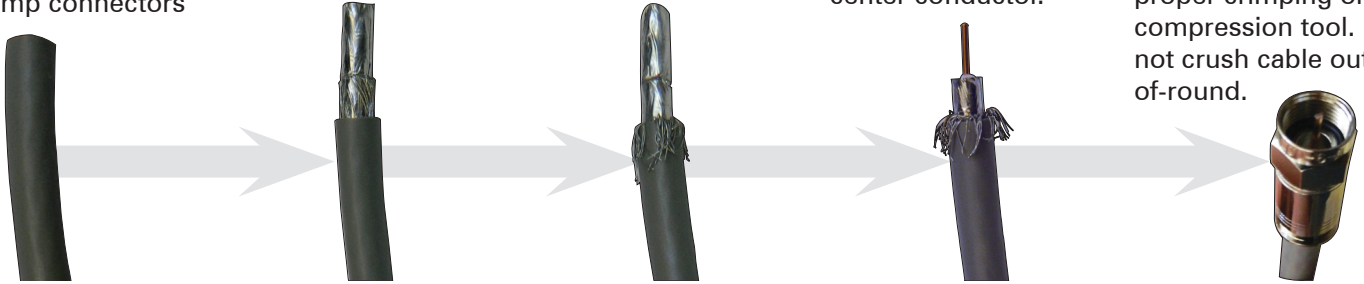

Notes

Parts

ORDERING REPAIR PARTS

Repair parts are available at many RV dealers and/or service centers throughout the country. If you don't have a dealer/service center near you, call Winegard Company at 1-800-288-8094. All major credit cards accepted. Parts are available **only** in the packages shown on the following pages. **Order by the model number of the package needed. Example:** To order the elevating gear, order RP-3000. Tax, shipping and handling additional.

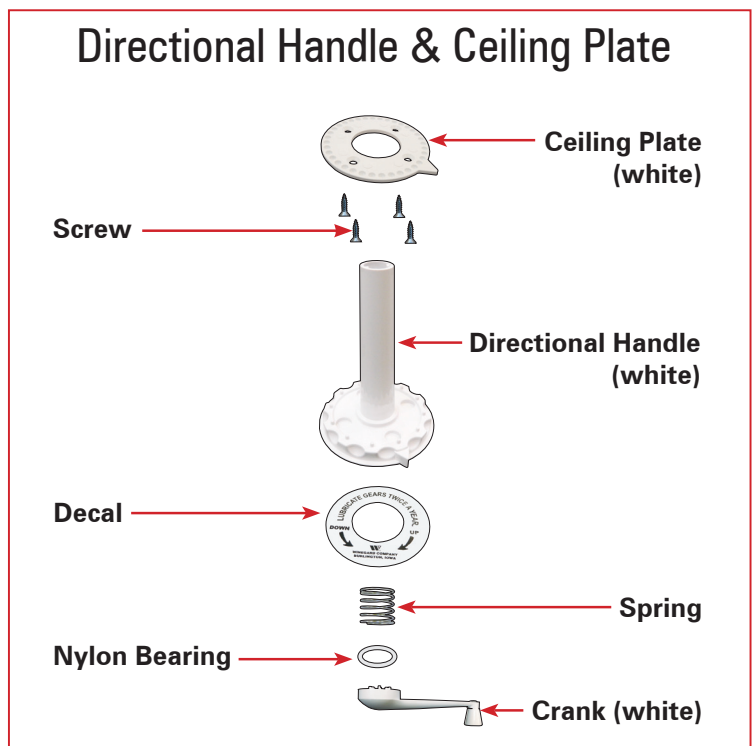
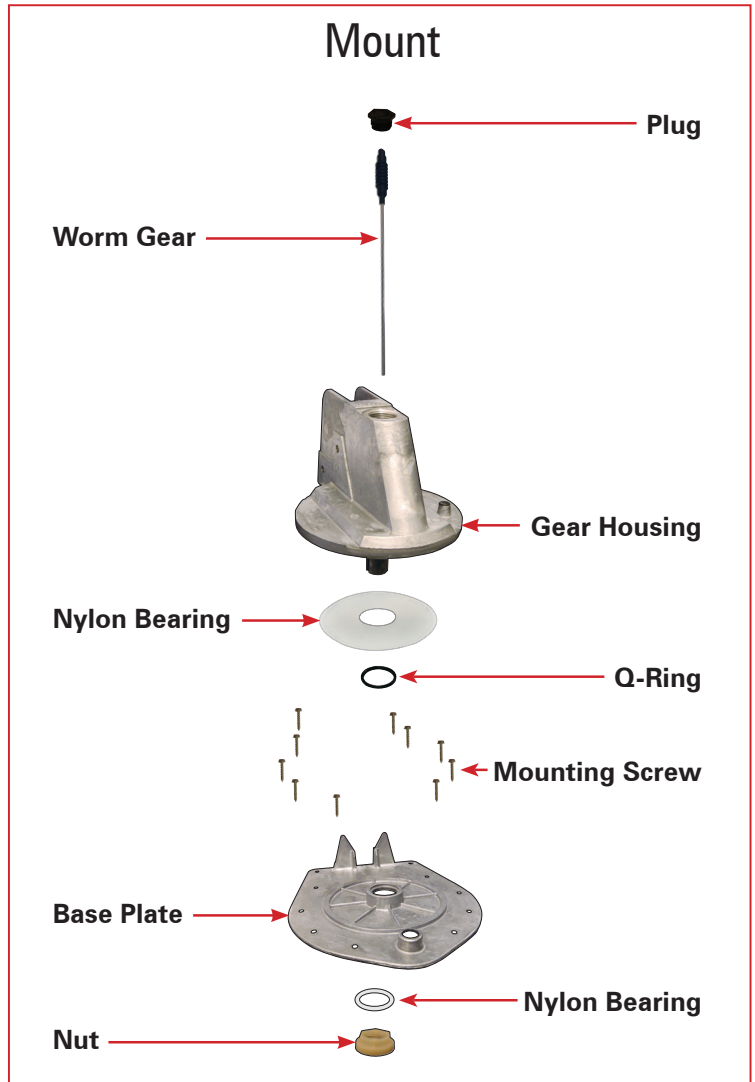
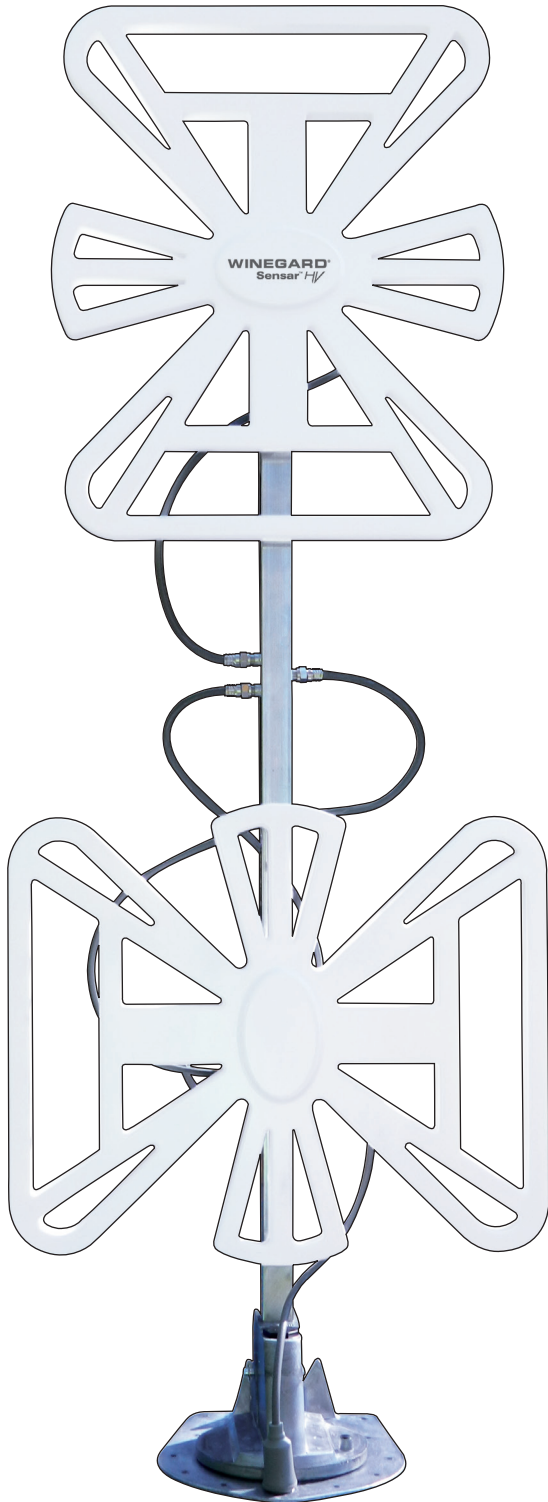

Parts

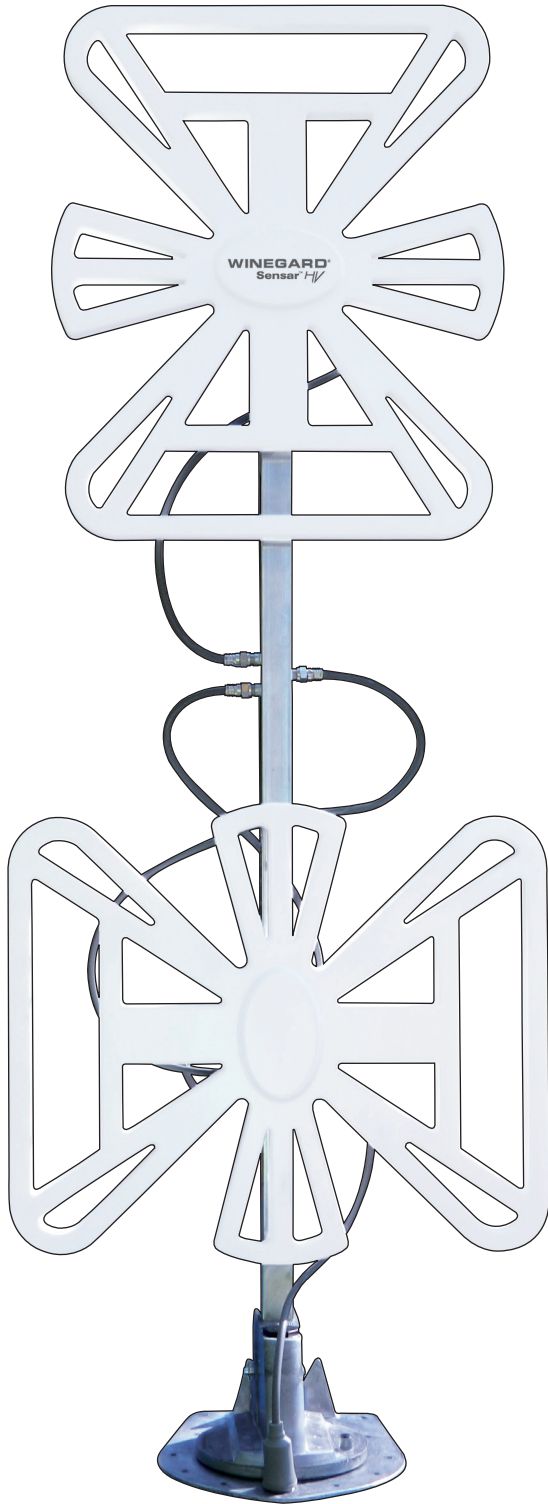



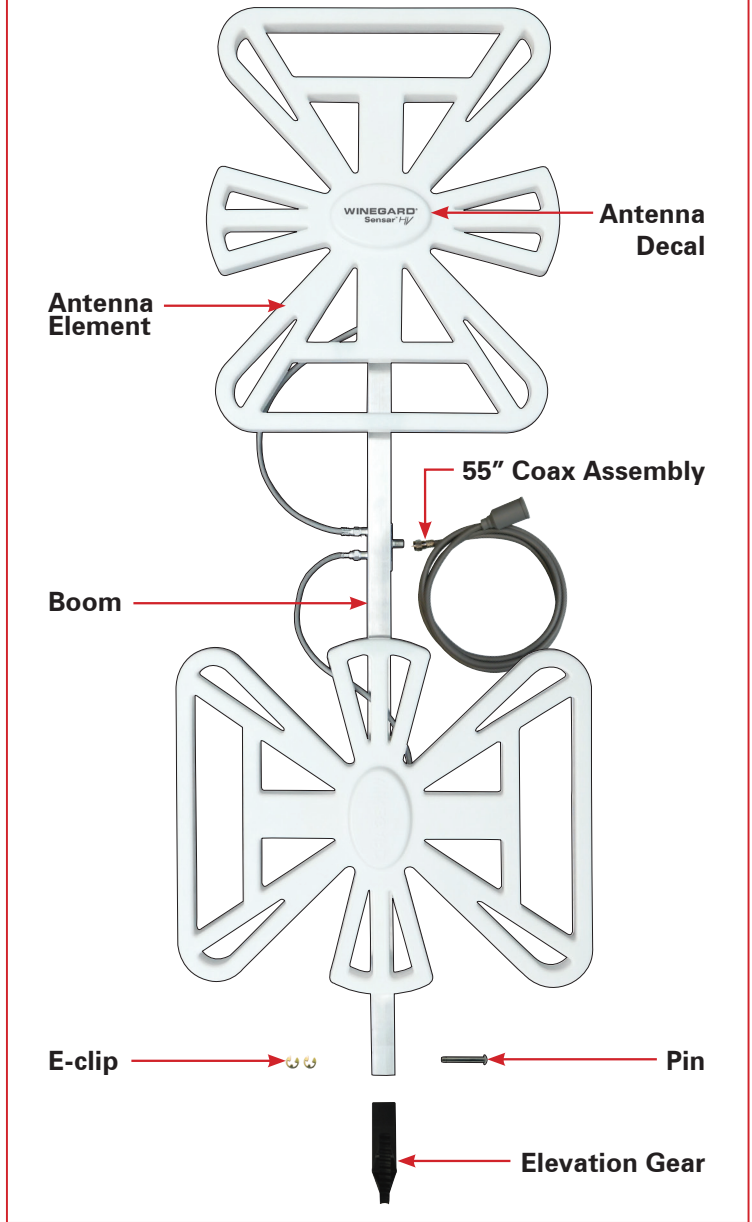





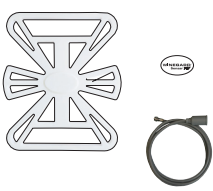
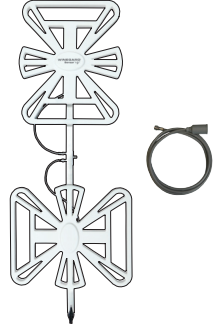

Antenna Head & Boom

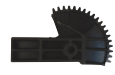
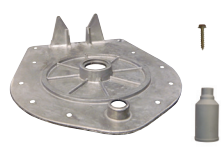
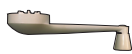

Additional Hardware



Replacement Kits & Parts

CC-RPHV: Antenna Element			CC-25HV: Retrofit Kit (Head Only)		
	Part Description	Quantity		Part Description	Quantity
	Antenna Decal (unattached)	1		Antenna Decal	1
	Antenna Element	1		CC-25HV Manual	1
	55" Coax Assembly	1		Boom Assembly	1
	CC-RPHV Manual	1		55" Coax Assembly	1
RP-0154: Boot					
	Part Description	Quantity	RP-2658: Nylon Bearing (for Crank)		
	Boot (light gray)	1		Part Description	Quantity
RP-2049: Gear Housing Assembly				Nylon Bearing	1
	Part Description	Quantity	RP-3000: Elevation Gear		
	Gear Housing	1		Part Description	Quantity
	Pin	2		Elevation Gear	1
	Nylon Nut	1	RP-3523: Base Plate		
	Nylon Bearing (for gear housing)	1		Part Description	Quantity
	E-Clip	2		Base Plate	1
Q-Ring	1	Mounting Screw		10	
Nylon Bearing (for base plate)	1	Light Gray Boot		1	
RP-5895: Crank (Ivory)			RP-6795: Crank (White)		
	Part Description	Quantity		Part Description	Quantity
	Crank (ivory)	1		Crank (white)	1
RP-6200: Directional Handle & Ceiling Plate (Ivory)			RP-6300: Directional Handle & Ceiling Plate (White)		
	Part Description	Quantity		Part Description	Quantity
	Spring	1		Spring	1
	Decal	1		Decal	1
	Ceiling Plate (ivory)	1		Ceiling Plate (white)	1
	Directional Handle (ivory)	1		Directional Handle (White)	1
	Screw	4		Screw	4
Elev.Shaft & Worm Gear Repl. Manual	1	Elev.Shaft & Worm Gear Repl. Manual	1		
RP-4000: Worm Gear Assembly			RP-6822: Spring		
	Part Description	Quantity		Part Description	Quantity
	Worm Gear	1		Spring	1
	Plug	1			
Manual	1				

**WINEGARD MOBILE PRODUCTS LIMITED WARRANTY
(2 YEARS PARTS; 1 YEAR LABOR)**

Winegard Company warrants this product against defects in materials or workmanship for a period of two (2) years from the date of original purchase. During year one (1) of such warranty, Winegard Company will also pay authorized labor costs to an authorized Winegard dealer to repair or replace defective products. No warranty claim will be honored unless at the time the claim is made, Customer presents proof of purchase to an authorized Winegard dealer (to locate the nearest authorized Winegard dealer, contact Winegard Company, 3000 Kirkwood Street, Burlington, Iowa 52601, Telephone 800-288-8094 or visit www.winegard.com). Customer must provide proof of purchase with a dated sales receipt for the Winegard product to verify the product is under warranty. If the date of purchase cannot be verified, the warranty period shall be considered to begin thirty (30) days after the date of manufacture.

If a defect in material or workmanship is discovered, Customer may take the product to an authorized Winegard dealer for service. Customer must provide proof of purchase to verify the product is under warranty. If the product is brought to an authorized Winegard dealer for service prior to expiration of year one (1) of the warranty period and a defect in material or workmanship is verified by Winegard Technical Services, Winegard Company will cover the Winegard dealer's labor charges for warranty service. The Winegard dealer must contact Winegard Technical Services in advance for pre-approval of the service. Approval of the service is at the sole discretion of Winegard Company.

Alternatively, Customer may ship the product prepaid to Winegard Technical Services (located at 3111 Kirkwood Street, Burlington, Iowa 52601, Telephone 800-788-4417). Customer must return the product along with a brief description of the problem and provide Winegard Technical Services with Customer's name, address, and phone number. Customer must also provide proof of purchase to verify the product is under warranty. If the product is returned before the expiration of the warranty period, Winegard Company will (at its option) either repair or replace the product.

This Limited Warranty does not apply if the product has been damaged, deteriorates, malfunctions or fails from: improper installation, misuse, abuse, neglect, accident, tampering, modification of the product as originally manufactured by Winegard in any manner whatsoever, removing or defacing any serial number, usage not in accordance with product instructions or acts of nature such as damage caused by wind, lightning, ice or corrosive environments such as salt spray and acid rain. This Limited Warranty also does not apply if the product becomes unable to perform its' intended function in any way as a result of the television signal provider making any changes in technology or service.

RETURN AUTHORIZATION POLICY

A Return Material Authorization (RMA) is required prior to returning any product to Winegard Company or Winegard Warranty Services under this warranty policy. Please call our Technical Services Department at 800-788-4417 or send an email to warranty@winegard.com to obtain the RMA number. Please furnish the date of purchase when requesting an RMA number. Enclose the product in a prepaid package and write the RMA number in large, clear letters on the outside of the package. To avoid confusion or misunderstanding, a shipment(s) without an RMA number(s) or an unauthorized return(s) will be refused and returned to Customer freight collect.

WINEGARD COMPANY DOES NOT ASSUME ANY LIABILITIES FOR ANY OTHER WARRANTIES, EXPRESS OR IMPLIED, MADE BY ANY OTHER PERSON.

ALL OTHER WARRANTIES WHETHER EXPRESS, IMPLIED OR STATUTORY INCLUDING WARRANTIES OF FITNESS FOR A PARTICULAR PURPOSE AND MERCHANTABILITY ARE LIMITED TO THE TWO YEAR PERIOD OF THIS WARRANTY.

In states that do not allow limitations on implied warranties, or the exclusion of limitation of incidental or consequential damages, the above limitations or exclusions do not apply.

Some states do not allow limitations on how long an implied warranty lasts, or the exclusion of limitation of incidental or consequential damages, so the above limitations or exclusions may not apply to you.

This warranty gives Customer specific legal rights. Customer may also have other rights that may vary from state to state.

SATELLITE RECEIVER WARRANTY:
See manufacturer's limited warranty policy.

WS-MOBWARREV2
Rev. 1/10

Disclaimer: Although every effort has been made to ensure that the information in this manual is correct and complete, no company shall be held liable for any errors or omissions in this manual. Information provided in this manual was accurate at time of printing. If the antenna does not function as expected, please contact Winegard Company at 1-800-788-4417, or visit our website at www.winegard.com.

Winegard Company • 3000 Kirkwood Street • Burlington, IA 52601
800-288-8094 • Fax 319-754-0787 • www.winegard.com • Printed in U.S.A.
©2011 Winegard Company Rev2 1/12 2452246

Winegard is a registered trademark of Winegard Company.
All trademarks are property of their respective owners.

FRONT OF RV



**Drill through roof.
Do not drill through ceiling!**

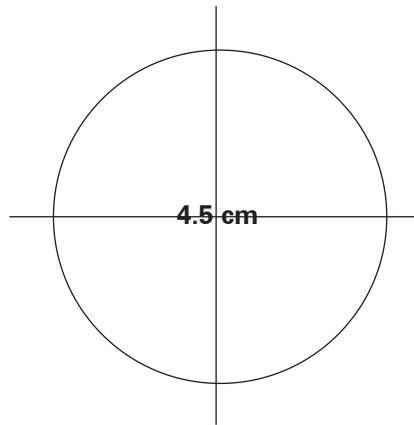

Drill completely through ceiling.

BACK OF RV





WINEGARD®